

MELSEC **Q** series

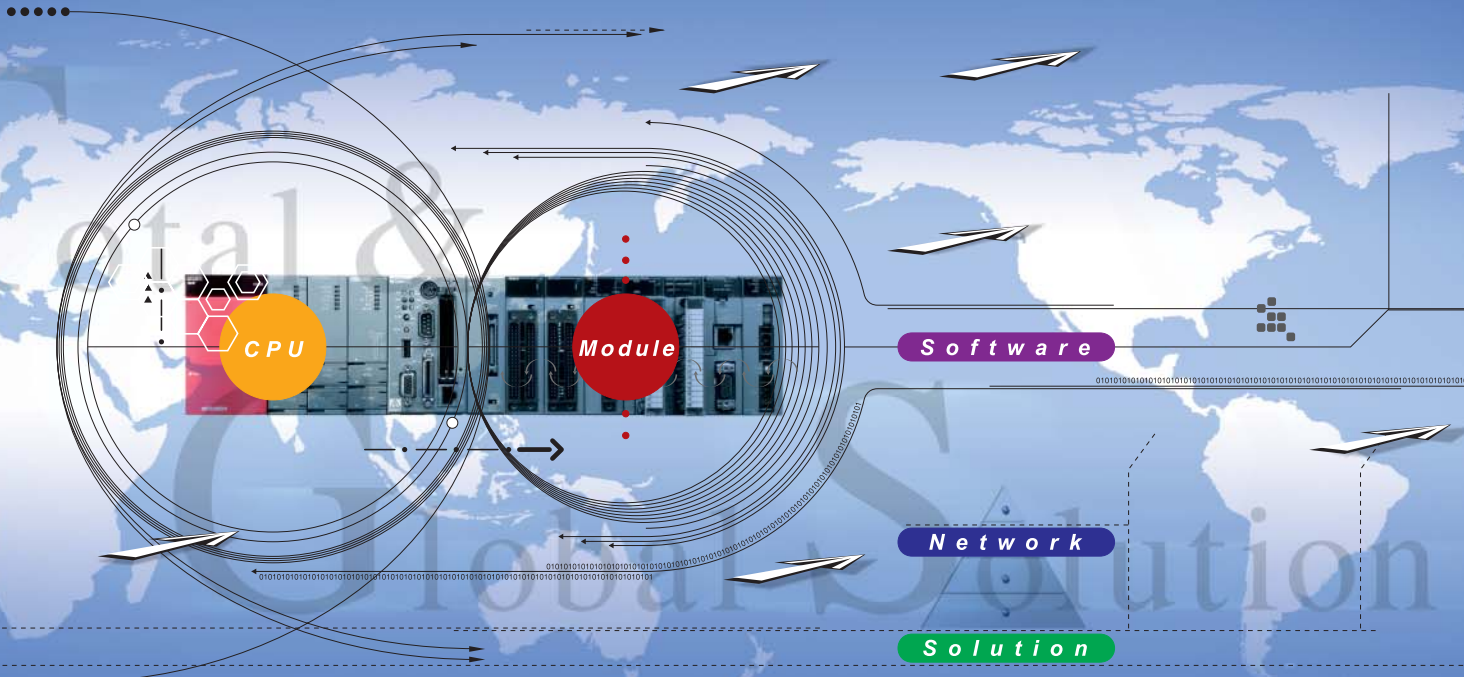

Mitsubishi Electric Corporation Nagoya Works is a factory certified for ISO14001 (standards for environmental management systems) and ISO9001 (standards for quality assurance management systems)

The automation solution specific to your needs

The MELSEC Q series offers 'total and global' solutions for a diverse range of applications.

The MELSEC Q series continues to advance the state of the art in automation control.

The Q series is an enhancement of Mitsubishi Electric's vast automation system expertise, while inheriting the technical assets from the MELSEC A and QnA series.

This unique series is able to integrate four types of automation control, sequence, motion, process, and information (PC based) onto a single system. Therefore, offering significant benefits for the user in terms of development, functionality, performance, and maintenance.

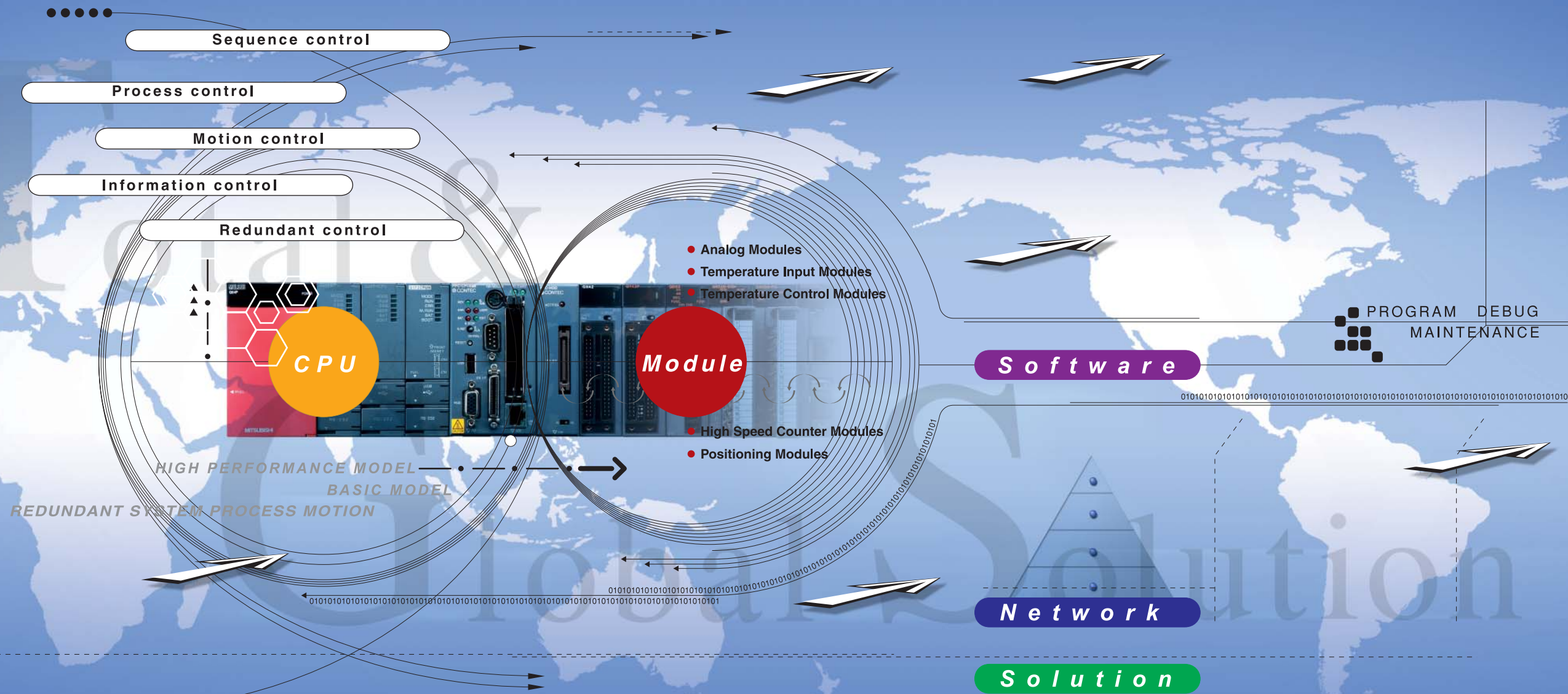

Total & Global Solution MELSEC Q series

I N D E X



Line Up 3



CPU 5



Network 13



Modules 21



Software 27



Solution 33



Specifications 41



Partner Products 45



World Wide Support 47



MELFANSweb/Information 48



Product List 50

Q series lineup

CPU Modules

PLC CPU

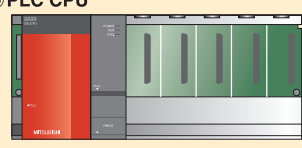

Basic Model QCPU

CPU type	Program capacity	Number of I/O points
Q00JCPU	8k steps	256 points
Q00CPU	8k steps	1024 points
Q01CPU	14k steps	1024 points

High Performance Model QCPU

CPU type	Program capacity	Number of I/O points
Q02CPU	28k steps	4096 points
Q02HCPU	28k steps	4096 points
Q06HCPU	60k steps	4096 points
Q12HCPU	124k steps	4096 points
Q25HCPU	252k steps	4096 points

Process CPU

CPU type	Program capacity	Number of I/O points
Q12PHCPU	124k steps	4096 points
Q25PHCPU	252k steps	4096 points

Redundant CPU

CPU type	Program capacity	Number of I/O points
Q12PRHCPU	124k steps	4096 points
Q25PRHCPU	252k steps	4096 points

Motion CPU

CPU type	Number of control axes
Q172HCPUN (-T)	8 axes
Q173HCPUN (-T)	32 axes
Q172CPUN (-T)	8 axes
Q173CPUN (-T)	32 axes

Network/Information Processing Modules

Ethernet Modules
 QJ71E71-100
 QJ71E71-B5
 QJ71E71-B2

MELSECNET/H Modules
 QJ71LP21-25 QJ72LP25-25
 QJ71LP21S-25 QJ72LP25G
 QJ71LP21G QJ72LP25GE
 QJ71LP21GE QJ72BR15
 QJ71BR11

MELSECNET/H PC I/F board
 Q80BD-J71LP21-25
 Q80BD-J71LP21S-25
 Q80BD-J71LP21GE
 Q80BD-J71BR11

CC-Link Module
 QJ61BT11N
 CC-Link interface board for personal computer
 Q80BD-J61BT11N

CC-Link/LT Module
 QJ61CL12

Serial Communication Modules
 QJ71C24N
 QJ71C24N-R2
 QJ71C24N-R4

FL-net (OPCN-2) Interface Modules
 QJ71FL71-T-F01
 QJ71FL71-B5-F01
 QJ71FL71-B2-F01

AS-I Master Module
 QJ71AS92

Intelligent Communication Modules
 QD51
 QD51-R24

Intelligent Function Modules

Analog Modules
 A/D Converter Modules
 Q64AD-GH
 Q62AD-DGH
 Q64AD
 Q68ADV
 Q68ADI

D/A Converter Modules
 Q62DA-FG Q68DAV
 Q62DA Q68DAVN
 Q62DAN Q68DAI
 Q64DA Q68DAIN
 Q64DAN

Temperature Control Modules
 Q64CTT
 Q64CTTBW
 Q64TCRT
 Q64TCRTBW

Temperature Input Modules
 Q64TDV-GH
 Q64TD
 Q64RD-G
 Q64RD

Loop Controller Module
 Q62HLC

Positioning Modules
 QD75P1 QD75MH1
 QD75P2 QD75MH2
 QD75P4 QD75MH4
 QD75D1 QD75M1
 QD75D2 QD75M2
 QD75D4 QD75M4

QD70P4
 QD70P8
 QD70D4
 QD70D8

Channel-Isolated Pulse Input Module
 QD70P8-G

High Speed Counter Modules
 QD62
 QD62D
 QD62E

Power Supply Modules

Q61P-A1 100 to 120VAC input 5VDC 6A output	Q61P-A2 200 to 240VAC input 5VDC 6A output	Q61SP<Slim type> 100 to 240VAC input 5VDC 2A output	Q62P 100 to 240VAC input 5VDC 3A output 24VDC 0.6A output
Q63P 24VDC input 5VDC 6A output	Q64P 100 to 120/200 to 240VAC input 5VDC 8.5A output	Q64RP 100 to 120/200 to 240VAC input 5VDC 8.5A output	Q63RP 24VDC input 5VDC 8.5A output

Memory Cards

SRAM cards
 Q2MEM-1MBS
 Q2MEM-2MBS

Flash cards
 Q2MEM-2MBF
 Q2MEM-4MBF

ATA cards
 Q2MEM-8MBA
 Q2MEM-16MBA
 Q2MEM-32MBA

PC card adaptor
 Q2MEM-ADP



Accessories

Batteries
 Q6BAT
 Q7BAT (-SET)
 Q8BAT (-SET)
 Q2MEM-BAT (for SRAM memory card)

Connectors for I/O Modules
 40-pin connector type
 A6CON1 (soldering type)
 A6CON2 (crimp-contact type)
 A6CON3 (pressure-displacement type)
 A6CON4 (soldering and inclined insertion combination type)

37-pin D sub connector type
 A6CON1E (soldering type)
 A6CON2E (crimp-contact type)
 A6CON3E (pressure-displacement type)

DIN rail Adapter
 Q6DIN1
 Q6DIN2
 Q6DIN3

Spring clamp Terminal Block
 Q6TE-18S

IDC Terminal Block Adaptor, Dedicated Tool
 Q6TA32
 Q6TA32-TOL

Connection Cable
 QC30R2

Connector Disconnection Prevention Holder
 Q6HLD-R2

Input Modules

Number of I/P points	100 to 120V AC	100 to 240V AC	24VDC (positive common)	5/12VDC (positive/negative common)	24VDC (negative common)
8 points		QX28	QX48Y57*1		
16 points	QX10		QX40 QX40-S1	QX70	QX80
32 points			QX41 QX41-S1 QH42P*1	QX71	QX81
64 points			QX42 QX42-S1	QX72	QX82 QX82-S1

*1: Input specifications for I/O composite module

Output Modules

Number of O/P points	Relay 24VDC, 240VAC	Triac 100 to 240VAC	Transistor 12 to 24VDC (sink)	Transistor 12 to 24VDC (sink/source)	Transistor 5 to 12VDC (sink)	Transistor 12 to 24VDC (source)
7 points			QX48Y57 0.5A/point*2			
8 points	QY18A 2A/point			QY68A 2A/point		
16 points	QY10 2A/point	QY22 0.6A/point	QY40P 0.1A/point QY50 0.5A/point		QY70 16mA/point	QY80 0.5A/point
32 points			QY41P 0.1A/point QH42P 0.1A/point*2		QY71 16mA/point	QY81P 0.1A/point
64 points			QY42P 0.1A/point			

*2: Output specifications for I/O composite module

Base Units, Extension Cables

Slim type main base unit

Main base unit (Power supply module required; cannot be extended)

2 I/O slots

3 I/O slots

5 I/O slots

Main base unit

Main base unit (Power supply module required; can be extended)

3 I/O slots

5 I/O slots

8 I/O slots

12 I/O slots

8 I/O slots

Extension Cables

QC05B (0.45m)
 QC06B (0.6m)
 QC12B (1.2m)
 QC30B (3.0m)
 QC50B (5.0m)
 QC100B (10.0m)

Tracking cable

QC10TR (1m)
 QC30TR (3m)

* Only the slim type power supply module (Q61SP) can be used.
 * This does not support the process CPU or redundant CPU.
 * The redundant CPU occupies two slots (CPU slot + module mounting slot).
 * The slim type power supply module (Q61SP) cannot be mounted.
 * The extension base cannot be used for the redundant CPU.

Other Modules

Interrupt Module
 QI60

Blank Cover
 QG60

MELSOFT

GX Developer
 MELSEC PLC programming software

GX Simulator
 MELSEC PLC simulation software

GX Explorer
 Project control tool

GX Converter
 Excel/text data converter

GX Configurator
 Intelligent function module setting and monitor tool

GX RemoteService-I
 Remote access tool

PX Developer
 FBD software package for Process control

MT Developer
 M-motion general startup support software

MR Configurator
 Servo setup software

MX Component
 ActiveX® library for communication

MX Sheet
 Excel communication support tool

CPU

C P U



Combine the CPUs to fit specific application requirements, from basic sequence control to advanced multiple CPU control.



Wide range & Multiple applications

Multiple solutions for a vast range of applications

BASIC MODEL
HIGH PERFORMANCE MODEL
PROCESS
MOTION MOTION
PROCESS
REUNDANT SYSTEM

CPU HIGH PERFORMANCE MODEL - MOTION PROCESS PERSONAL COMPUTER
BASIC MODEL

Q series CPU lineup provides answers for a vast range of application requirements.

The Q series lineup covers a various range of applications be it, PLC, process, motion, or information control. The basic model QCPU range is designed ideally for small scale applications. With the unique Multiple CPU functionality, each process area of the application can be selectively controlled by different CPUs situated on the same main base unit. Therefore, this lineup provides an ideal solution for each required application.

The redundant CPU system ensures robust operation in the event of trouble.

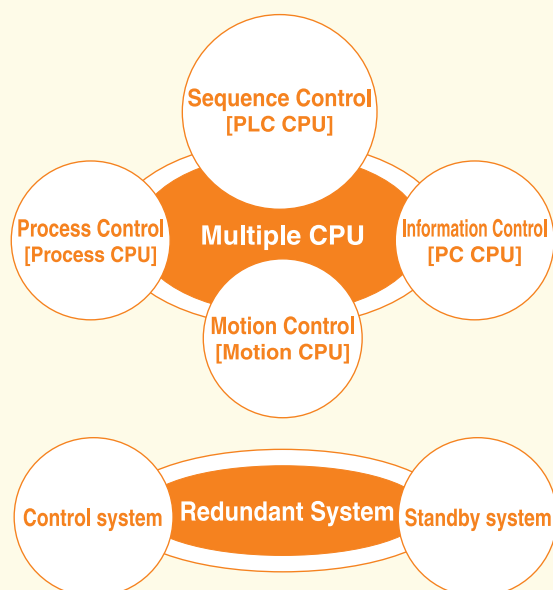

Combine up to 4 CPUs on a single Q series system to provide the ideal solution for your application.

PLC CPU Basic Model QCPU

- Q00JCPU** • Program Capacity: 8K steps • Number of I/O Points: 256 points
• Number of I/O device points: 2048 points
• Integrated CPU with power supply and 5 slots
- Q00CPU** • Program Capacity: 8K steps • Number of I/O Points: 1024 points
• Number of I/O device points: 2048 points
- Q01CPU** • Program Capacity: 14K steps • Number of I/O Points: 1024 points
• Number of I/O device points: 2048 points

High Performance Model QCPU

- Q02CPU** • Program Capacity: 28K steps • Number of I/O Points: 4096 points
• Number of I/O device points: 8192 points
- Q02HCPU** • Program Capacity: 28K steps • Number of I/O Points: 4096 points
• Number of I/O device points: 8192 points
- Q06HCPU** • Program Capacity: 60K steps • Number of I/O Points: 4096 points
• Number of I/O device points: 8192 points
- Q12HCPU** • Program Capacity: 124K steps • Number of I/O Points: 4096 points
• Number of I/O device points: 8192 points
- Q25HCPU** • Program Capacity: 252K steps • Number of I/O Points: 4096 points
• Number of I/O device points: 8192 points

High performance CPUs with a diverse and powerful process control instruction set.

Process CPU (MELSEC Process Control)

- Q12PHCPU** • Program Capacity: 124K steps • Number of I/O Points: 4096 points
• Number of I/O device points: 8192 points
- Q25PHCPU** • Program Capacity: 252K steps • Number of I/O Points: 4096 points
• Number of I/O device points: 8192 points

Redundant CPUs with robustness

Redundant CPU

- Q12PRHCPU** • Program Capacity: 124K steps • Number of I/O Points: 4096 points
• Number of I/O device points: 8192 points
- Q25PRHCPU** • Program Capacity: 252K steps • Number of I/O Points: 4096 points
• Number of I/O device points: 8192 points

Designed for next generation's high-speed motion and multi-axis control.

Motion CPU

- NEW Q172HCPU** • SSCNET III compatible • For 8-axis control
- NEW Q173HCPU** • SSCNET III compatible • For 32-axis control
- NEW Q172HCPU-T** • SSCNET III compatible • For 8-axis control • Teaching module compatible
- NEW Q173HCPU-T** • SSCNET III compatible • For 32-axis control • Teaching module compatible
- Q172CPUN** • For 8-axis control
- Q173CPUN** • For 32-axis control
- Q172CPUN-T** • For 8-axis control • Teaching module compatible
- Q173CPUN-T** • For 32-axis control • Teaching module compatible

A fully featured Microsoft™ Windows™ personal computer directly on the Q Series base unit.

Personal Computer CPU

[Partner products]
Offers unlimited open control opportunities while maintaining tight integration with other Q Series system components.

Refer to pages 45 to 46 for details on the partner product.





High performance and flexibility on a small footprint

Mounting Area

In the Q series, 2, 3, 5, 8 and 12 I/O slots main base units are available. The mounting area can be further reduced by using the slim type base unit.

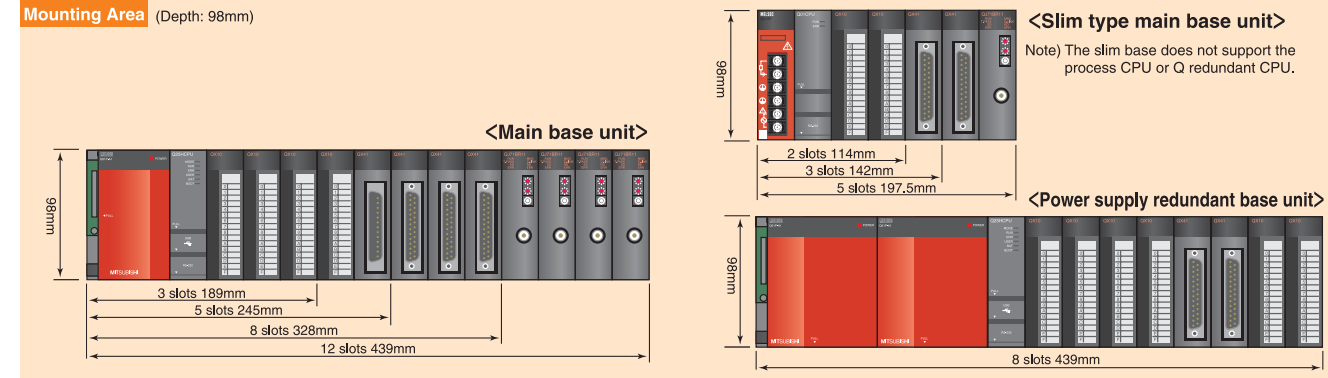

Mounting Freedom

Choose from 2, 3, 5, 8 and 12 I/O slot bases to design the best system for the required application. Connect extension bases directly by using cables alone. Therefore, no need for network modules, adapters, or configuration software to distribute base units over an extended distance. Extension bases that do not require a power supply module are available to further reduce space and costs.

Types of slim type main base units (power supply module required)

Number of I/O Slots	Main Base	Mounting Dimensions (mm)
2	Q32SB	114 × 98
3	Q33SB	142 × 98
5	Q35SB	197.5 × 98

Note) The slim type main base unit cannot be connected with an extension base. This does not support the process CPU or redundant CPU.

Up to 7 Extension Bases Connectable

Up to seven extension bases (eight when counting the main base) can be connected to accept up to 64 modules. Also, the overall distance of extension cables is max. 13.2m, enabling high freedom for designing the system base layout.

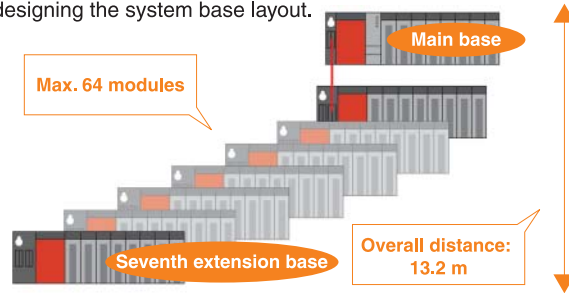

Base unit types (power supply module required)

Number of I/O Slots	Main Base	Extension Base	Mounting Dimensions (mm)
3	Q33B	Q63B	189 × 98
5	Q35B	Q65B	245 × 98
8	Q38B	Q68B	328 × 98
12	Q312B	Q612B	439 × 98

Power supply redundant base unit

Number of I/O Slots	Redundant Main Base	Redundant Extension Base	Mounting Dimensions (mm)
8	Q38RB	Q68RB	439 × 98

Base unit types (Requires no power supply module)

Number of I/O Slots	Extension Base	Mounting Dimensions (mm)
2	Q52B	106 × 98
5	Q55B	189 × 98

CPU		Number of Extension Base Units	Number of Loaded Modules	Overall Extension Cable Length (m)
Basic Model	Q00JCPU	2 (max.)	16 (max.) ^(Note 3)	13.2 (max.)
	Q00CPU			
	Q01CPU			
High-Performance Model	Q02CPU	7 (max.)	64 (max.) ^(Note 3)	
	Q02HCPU			
	Q06HCPU			
	Q12HCPU			
	Q25HCPU			
Process CPU	Q12PHCPU	0 ^(Note 1)	11 (max.) ^(Note 2)	
	Q25PHCPU			
Redundant CPU	Q12PRHCPU	0 ^(Note 1)	11 (max.) ^(Note 2)	
	Q25PRHCPU			

Note 1) Non-redundant modules are all mounted on the remote station side. (Up to 64 modules can be mounted on one remote station.)

Note 2) Up to seven power supply redundant modules can be mounted.

Note 3) If a 12-slot base is used, the maximum number of I/O, intelligent function and network modules mounted is 16/24/64 respectively.

Number of Control I/O Points

The Q series can control a maximum of 8192 points (input device points) in a remote I/O network such as CC-Link, or a maximum of 4096 points (I/O points) for direct I/O only.

Note 1) Number of I/O points on main and extension bases directly controllable by a CPU module.

Note 2) Total number of I/O points on main and extension bases directly controllable by a CPU module and I/O points that can be controlled as remote I/O by a remote I/O network.

CPU		Number of I/O Points ^(Note 1)	Number of I/O Device Points (Including remote I/O points) ^(Note 2)
Basic Model	Q00JCPU	256	2048
	Q00CPU		
	Q01CPU		
High-Performance Model	Q02CPU	4096	
	Q02HCPU		
	Q06HCPU		
	Q12HCPU		
	Q25HCPU		
Process CPU	Q12PHCPU	4096	
	Q25PHCPU		
Redundant CPU	Q12PRHCPU	4096	
	Q25PRHCPU		

Increased Operation Processing Speeds

Q series offers some of the highest processing performance on the market today; basic instruction processing time is 34ns and PC MIX value is 10.3. By Mitsubishi's own "PC-MIX" performance metric, it is about 5 times faster than A2USHCPU-S1 and about 2.7 times faster than the Q2ASHCPU. The CPU has dramatically increased floating-point operation speeds for PID and other arithmetic functions. The PC-MIX aims to replicate real-world application performance by executing a mixed instruction set.

PC MIX value comparison

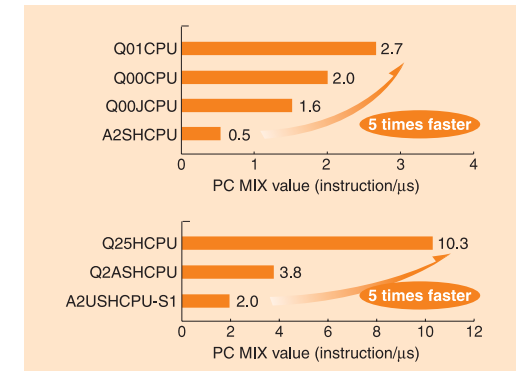

CPU operation processing speeds

Instruction	Basic Model				High-performance Model		
	Q00JCPU	Q00CPU	Q01CPU	Q02CPU	Q02HCPU	Q12PHCPU	Q12PRHCPU
LD (LD X0)	200ns	160ns	100ns	79ns	34ns		
OUT (OUT Y0)	200ns	160ns	100ns	158ns	68ns		
Timer (OUT T0 K5)	1100ns	880ns	550ns	632ns	272ns		
Transfer (MOV D0 D1)	700ns	560ns	350ns	237ns	102ns		
Addition (+ D0 D1)	1000ns	800ns	500ns	395ns	170ns		
Floating-point addition (E+)	65.5μs	60.5μs	49.5μs	1815ns	782ns		
PC MIX value (Instruction/μs)	1.6	2.0	2.7	4.4	10.3		

* The PC MIX value is the average number of instructions such as the basic and data processing instructions executed in 1 μs. A larger value indicates a higher processing speed.

Program Capacities and Large Standard RAM Capacities

To construct small to large scaled systems, the Q series has a wide variation of CPU modules having 8k to 252k step program capacities and up to 256k bytes, large-capacity standard RAMs, to meet the application requirements from basic sequence control up to complex multi-discipline applications. A standard ROM (flash ROM) is built-in to enable ROM operation without a memory card. The efficient use of memory space allows the Q series CPU to contain substantially more the program than the A series CPU. (Example: the basic model CPUs contain twice the program of A series.)

CPU		Program Capacities (Steps)	Device Memory (Words)	Standard RAM (Bytes) ^(Note)	Standard ROM (Bytes)	Memory Card (Number of slots)
Basic Model	Q00JCPU	8k	18k	No	58k	No
	Q00CPU					
	Q01CPU					
High-Performance Model	Q02CPU	28k	29k	64k	112k	1
	Q02HCPU					
	Q06HCPU					
	Q12HCPU					
	Q25HCPU					
Process CPU	Q12PHCPU	124k	29k	256k	496k	1
	Q25PHCPU					
Redundant CPU	Q12PRHCPU	124k	29k	256k	496k	1
	Q25PRHCPU					

Note) Memory that stores the data used in sequence programs such as file registers and local devices (with the exception of Basic Model CPU). As a built-in type RAM, the sequence program having a lot of file registers and local devices stored in standard RAM can run rapidly.

Extended Memory

The high-performance model QCPU, process CPU and redundant CPU are equipped with a small PC card I/F into which the following extension memory can be mounted: SRAM card: 1M/2Mbyte, Flash card: 2M/4Mbyte, ATA card: 8M/16M/32Mbyte. This large capacity extension memory facilitates management of large files. The extension memory allows massive system documentation to reside in the controllers. Storage for file register data, device comments and program histories is also possible.

Memory capacity

Type	Memory card type	Memory card capacity	Number of storable files (files)
SRAM card	Q2MEM-1MBS	1011.5k bytes ^(Note)	256
	Q2MEM-2MBS	2034k bytes ^(Note)	
FLASH card	Q2MEM-2MBF	2035k bytes	288
	Q2MEM-4MBF	4079k bytes	
ATA card	Q2MEM-8MBA	7940k bytes ^(Note)	512
	Q2MEM-16MBA	15932k bytes ^(Note)	
	Q2MEM-32MBA	31854k bytes ^(Note)	

Note) The SRAM card and ATA card memory capacity is the value after formatting.

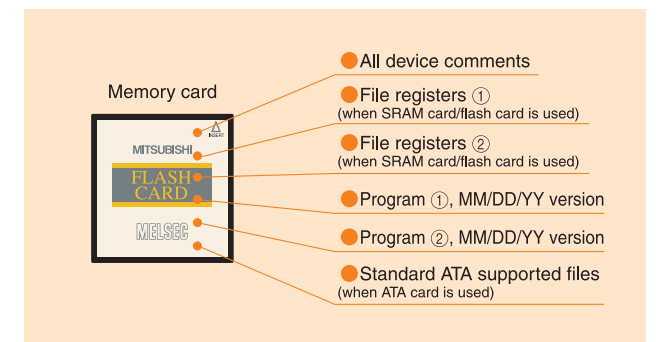



Multi CPUs break through the limitation of PLC.

Multiple CPU System Configuration

The Q series can combine multiple CPUs together on the same system to build the required application configuration. Control of I/O modules can be segmented between different CPUs. CPUs communicate with each other via shared memory, and can increase system performance by distributing tasks between different CPUs. A variety of methods exist for controlling the methods by which CPUs communicate, but in each case the development effort is simplified by available software tools.

* The redundant CPU does not support the multiple CPU.

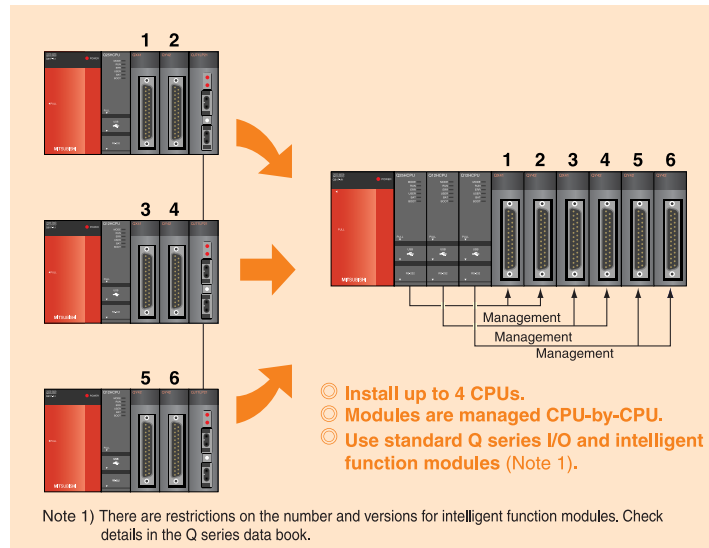

Integration of Process CPU, Motion CPU, and PC CPU

The Q series multiple CPU system function allows PLC CPU, process, motion, and personal computer CPUs to be mounted together, enabling utilization of their respective strong points and design of an optimal system.

Note) Only the following combinations can be used with the Basic Model.
 - Basic Model CPU + Motion CPU
 - Basic Model CPU + PC CPU
 - Basic Model CPU + Motion CPU+ PC CPU

* SSCNET is a high-speed serial communication network that links motion CPUs and servo amplifiers with less wiring. SSCNET & SSCNETII are metal cable types, and SSCNETIII is an optical fiber cable type.

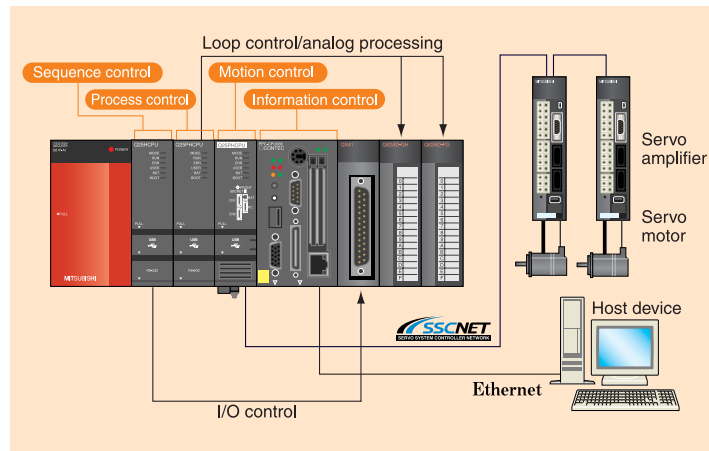

The broader line-up of CPU provide solution for diverse area of control.

Process Control

Process CPU

Q series offers a feature that rivals those of costly DCS systems at a fraction of the cost. Q Series is adept at the automation of process systems with the simple addition of one or more process CPUs to the controller. The process CPUs are complemented by a range of channel-isolated high resolution analog I/O modules with online change (hot-swap) capability, and the PX Developer function block programming software environment. (Refer to the "MELSEC Process Control Catalog" for more information on the process CPU.)

- The "Process CPU" builds on the capability of the equivalent sequence CPU with the addition of an array of powerful process instructions.
- "Channel-isolated high resolution analog module" further enhance process control using the PLC.
- A highly specialized instrumentation control system can be easily built using the engineering environment provided by the PX Developer instrumentation control software.
- Easy maintenance and high reliability are possible due to features which permit online module changes, etc.
- Combine the Process CPUs with the redundant network capabilities of the MELSECNET/H control level network. This offers high performance, robust, and deterministic communications between multiple Q Series systems, regardless of their assigned control tasks.



System configuration example

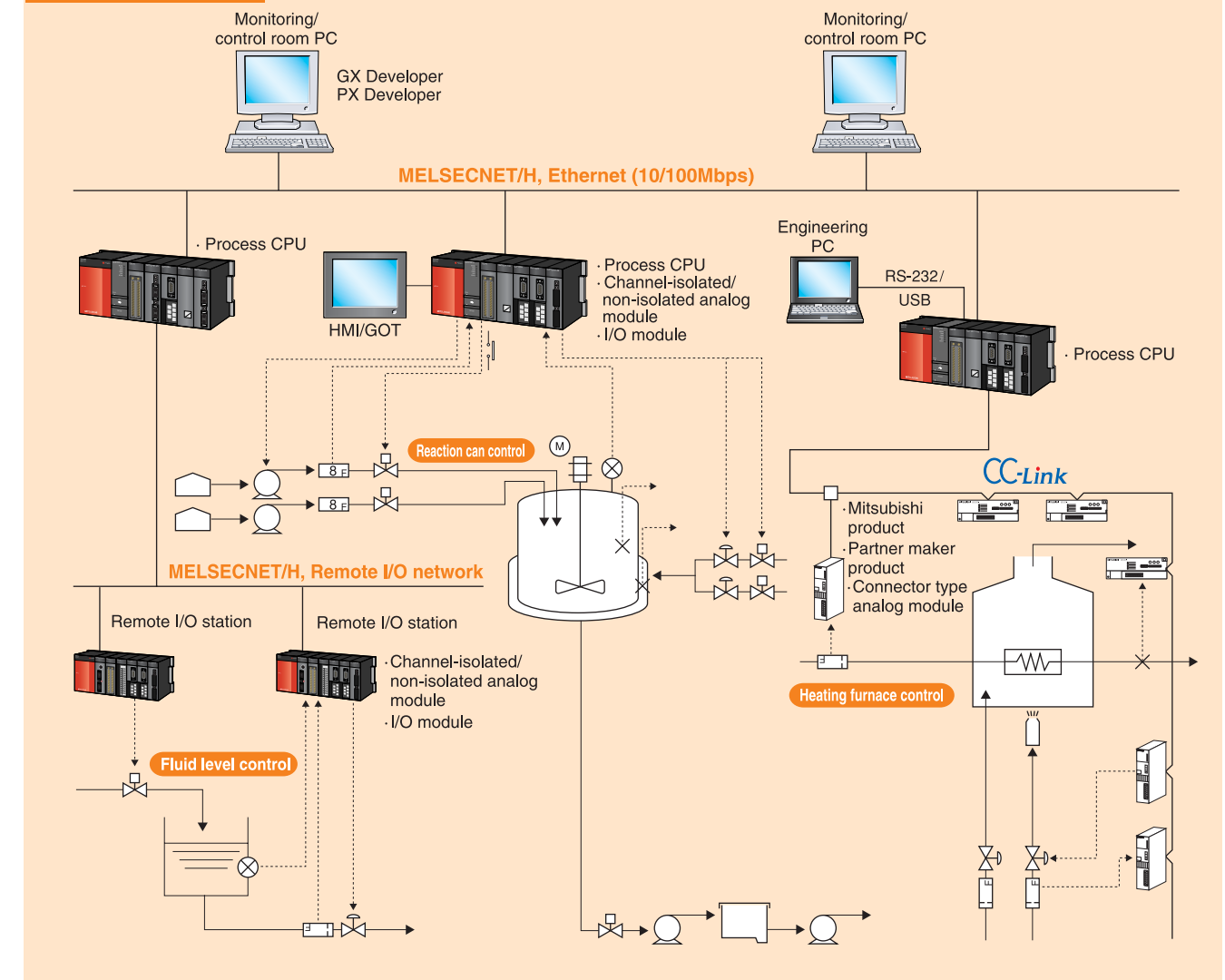



Redundant CPU system

Redundant CPU

The redundant system prevents the sudden fault. An entire system including the power supply module, CPU and base unit is designed with redundancy. It provides the suitable system for diverse area of automation.



- Even if a failure occurs in the control system, the standby system takes over the control to continue the system operation.
- The Q series product such as I/O, intelligent and network modules can be used without any changes (except for some modules).
- The remote I/O reduces risks with decentralized control.
- GX Developer and PX Developer offer simple engineering environment for redundant system settings with the original operability.

System configuration example

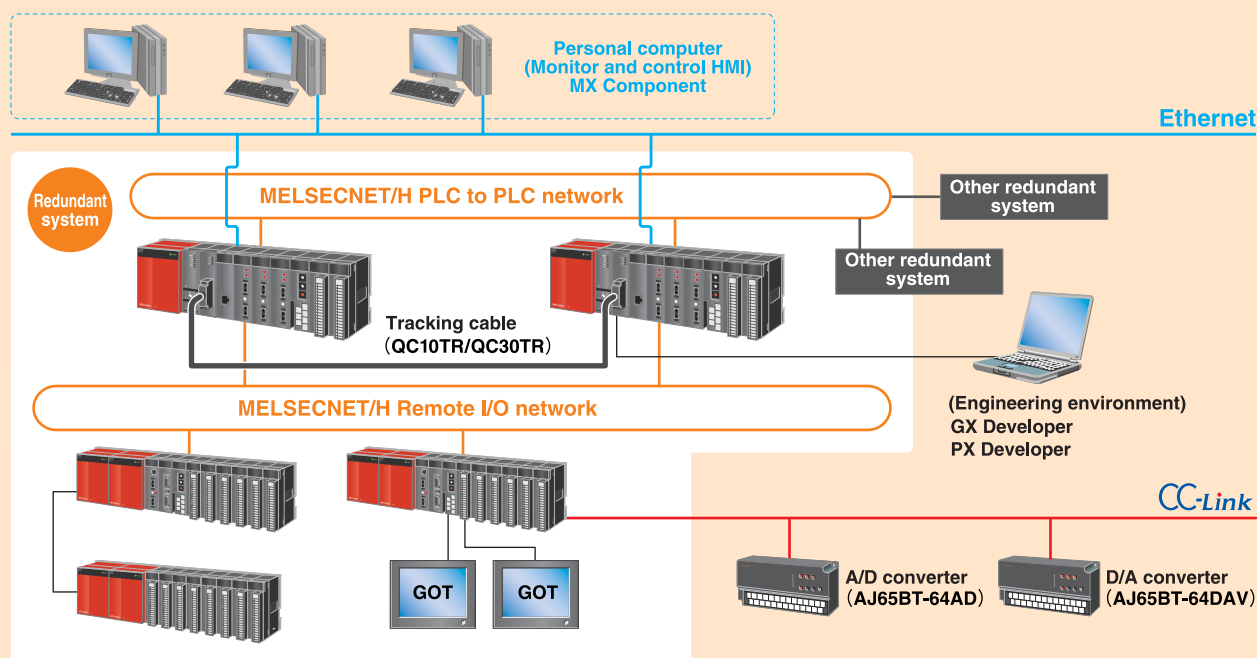

Easy program modification for both control and standby systems

- Write programs and parameter files to PC
- Online change while editing a program

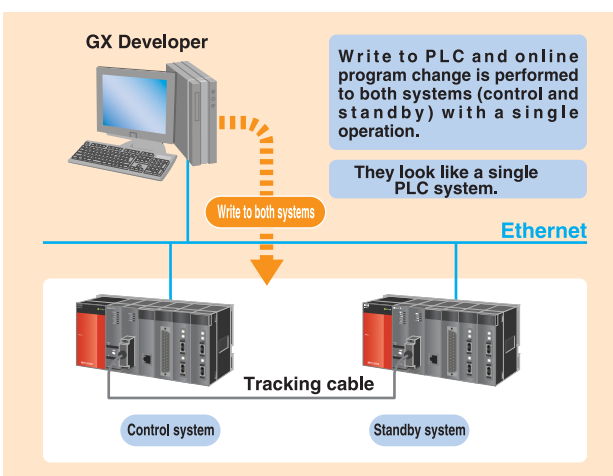

Continue operations even at system switching

If system switching occurs due to a stop error inside the CPU, the access target is automatically switched to the other system via the network. This enables continuous operation so that the user need not pay attention to system switching.

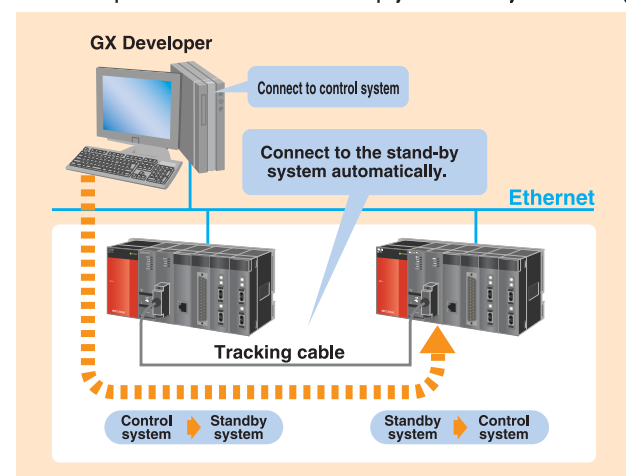

Motion Control

Motion CPU

Mitsubishi Electric motion controller realizes high-speed control of up to 32 axes (96 axes when using the maximum three multiple CPUs) with one CPU having the same size as the Q Series PLC. This offers large cost savings, especially when complex wiring is eliminated due to the "daisy-chain" connection of Mitsubishi intelligent digital servos. (Refer to the "Motion Controller Catalog" for more information on the Motion CPU.)



- Offers a minimum motion operation cycle time of 0.44ms (when using Q172HCPU / Q173HCPU), faster cam operation, and a shorter operation tact.
- Together with the shortened communication cycle time (0.44ms), the synchronization performance and speed/positioning control accuracy is substantially improved.
- Motion CPU can be used together with any type of Q series CPU as required.
- Via Mitsubishi's high performance SSCNET motion network technology, Q series offers significant engineering and operation benefits for motion control.

* SSCNET is a high-speed serial communication network that connects the motion CPU and servo amplifier. SSCNET is available with a metal cable (SSCNET/SSCENT II) or an optical fiber (SSCNET III) cable.

System configuration example

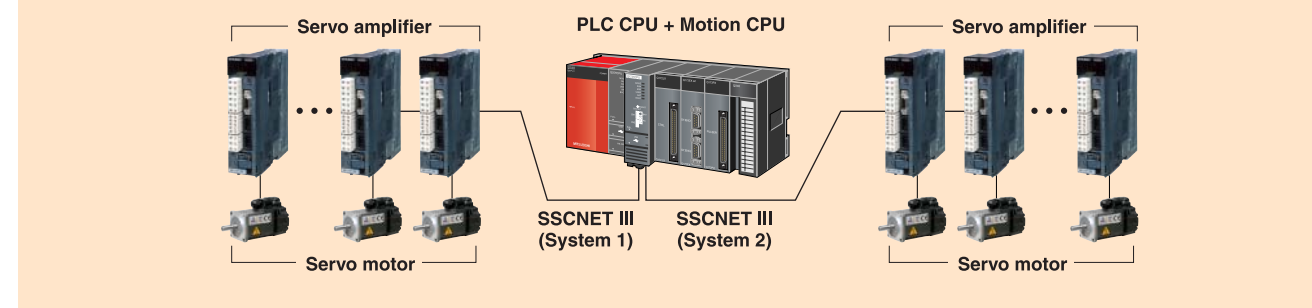

Information Control

PC CPU

Q series is unique in being able to mount a full-featured Windows™ PC in a robust industrial format directly on the Q series base unit. This offers the potential to combine it with other Q series CPU types, therefore fully integrating it into the Q I/O system to give complete access to all I/O modules and networking, allowing maximum design flexibility.



- Industrial specification level environmental and noise performance specifications.
- Choose HDD or silicon disk mass storage depending on the operating environment.
- Utilize third party PC applications available for Microsoft™ Windows™, offering a virtually unlimited application scope.
- Includes a wide variety of ports and connections to add third party hardware devices.

Note) The PC CPU is manufactured by CONTEC, Co., Ltd. Refer to the "Partner Products" on pages 45 and 46 for more information.

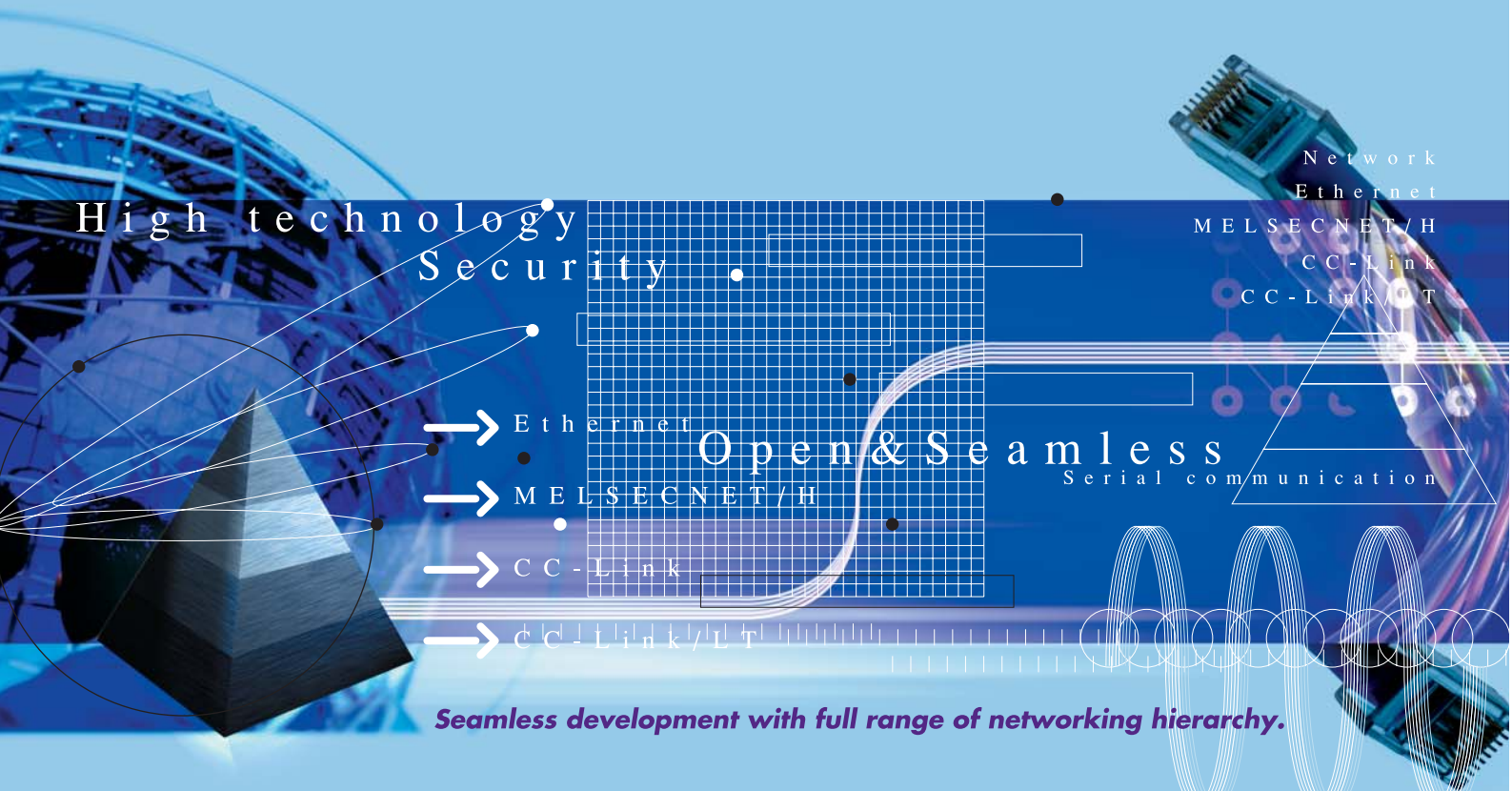

Seamless development with full range of networking hierarchy.

Networking support at all levels of the automation hierarchy, scalable to fit any application size

Modern plant systems require networking at many different levels. With Q series, Mitsubishi offers a networking solution that matches these specific requirements. The Mitsubishi solution ranges from top level factory LAN 100Mbit Ethernet, mid-level shop floor control MELSECNET/H, down to device level CC-Link, and CC-Link/LT. The open network CC-Link, which originates from Japan, is a SEMI certified wire saving network, providing the seamless networking required with modern applications. Therefore, the Q series provides a range of network types within each level of the hierarchy to ensure the right solution is provided.

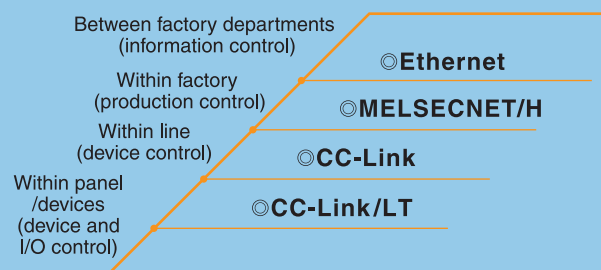

Network modules overview

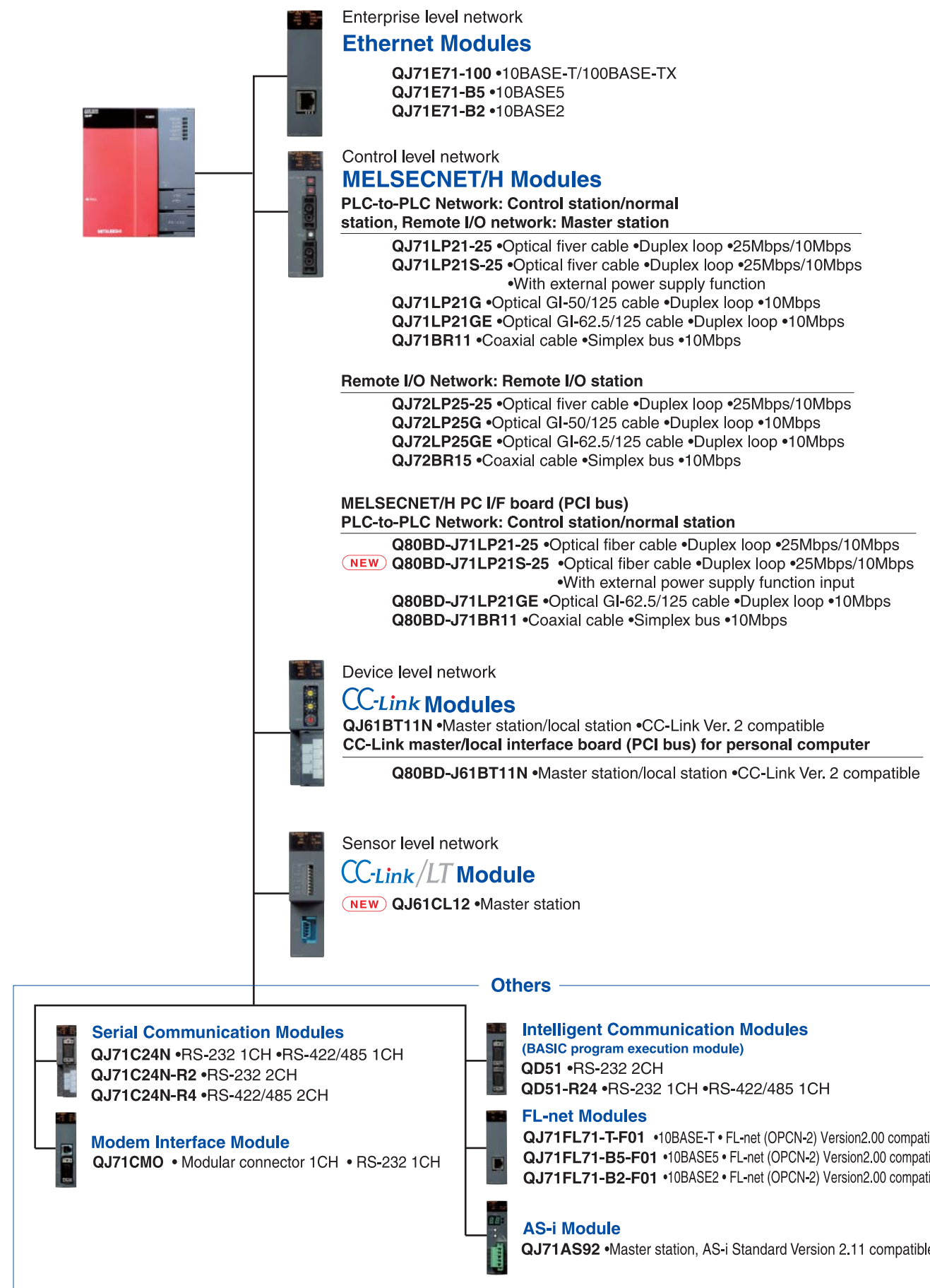



Q series network environment connecting to the future for more freedom.

Seamless integration of the network over all layers

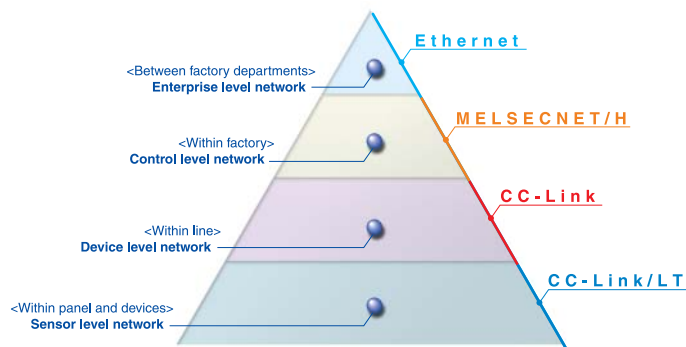

Q series support for open networking.

Q series provides extensive support for applications requiring a diverse range of 3rd party devices on the same network. An example is the open CC-Link device network, which originated from Japan through Mitsubishi, and is now administered by the CC-Link Partner Association (CLPA). CC-Link is a SEMI certified network, with many products available from over 500 different partner companies, with over 1.5 million installed nodes.

Seamless communication

Q series combines enterprise, control, and device level networks together through Ethernet, MELSECNET/H, and CC-Link to allow easy information access, no matter what level it resides on the network hierarchy. It is possible to "drill down" from a high level Ethernet down through multiple network layers, to program the PLC just by having GX Developer installed on the PC.

Event interrupt

Some network and intelligent function modules include an event interrupt function that can interrupt the high performance QCPU program. With this function, the CPU can rapidly respond to an event that occurs asynchronously with the program scan of the PLC, e.g. data receiving from a network or value compare of a high-speed counter.

Remote password

The High-Performance Model QCPU includes a remote password function to provide additional security over remote access. The remote password can be changed or deleted as from within the parameters.

External power supply input capability

Data link can be maintained even if the PLC power fails by using the QJ71LP21S-25 module with external power supply input for MELSECNET/H.

Network diagnostics

GX Developer includes extensive built-in diagnostic tools for Ethernet, MELSECNET/H, CC-Link, and CC-Link/LT. Refer to page 29 for details.

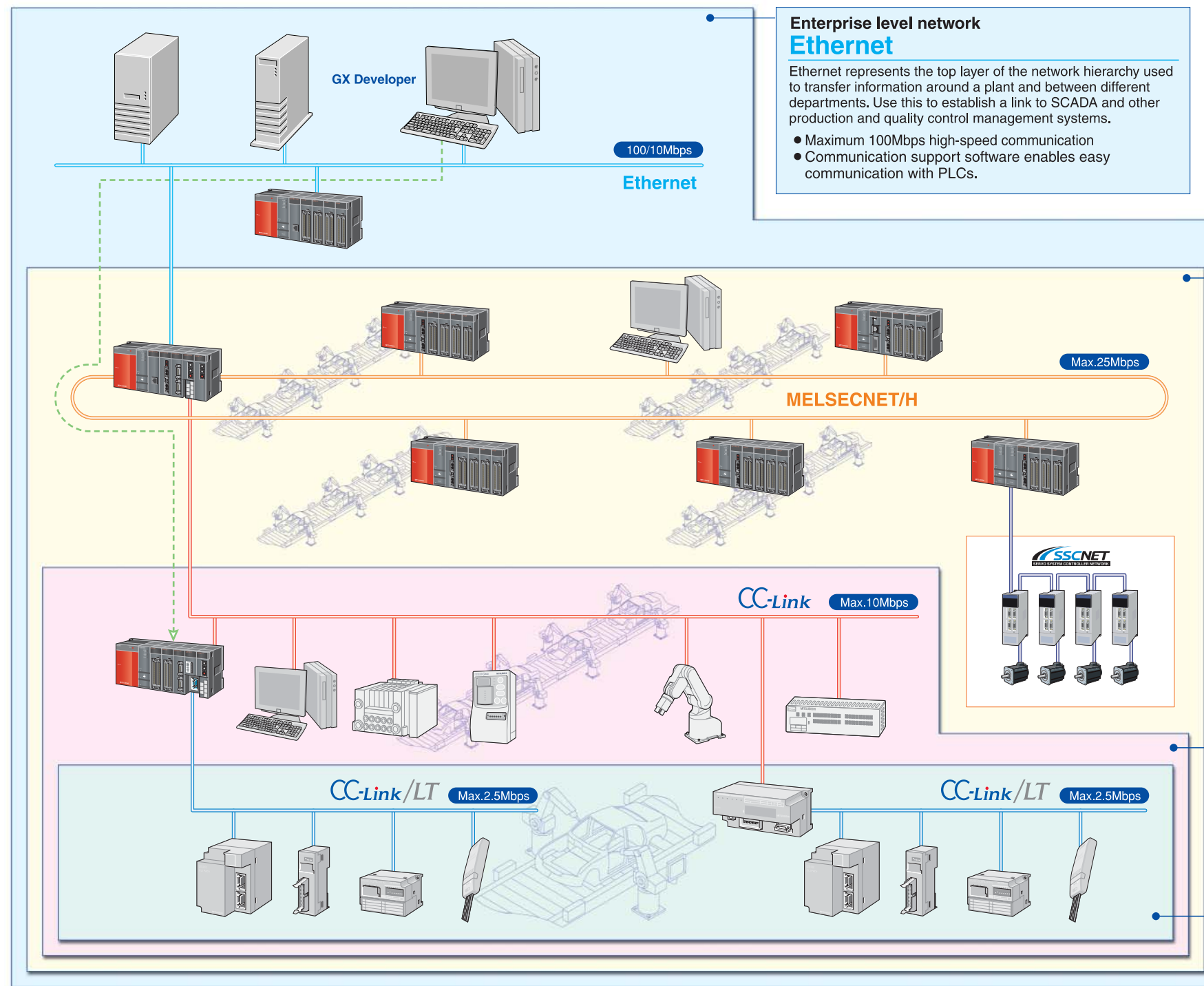

Enterprise level network Ethernet
 Ethernet represents the top layer of the network hierarchy used to transfer information around a plant and between different departments. Use this to establish a link to SCADA and other production and quality control management systems.

- Maximum 100Mbps high-speed communication
- Communication support software enables easy communication with PLCs.

Control level network MELSECNET/H
 MELSECNET/H is one step down from Ethernet and allows communication between controllers on a line within a plant department. MELSECNET/H offers high performance, fault tolerant, deterministic communications for line interlocking and synchronization between different processes.

- Maximum 25Mbps high-speed communication
- Large capacity link device: 16,384 points each for bits and words
- Improved reliability using duplex optical fiber loop
- No "per station" transmission data amount restrictions.

Device level network CC-Link
 The primary reason for a device level network is to link a controller to numerous different devices to reduce wiring costs while adding additional benefits such as improved diagnostic capability. Together with SEMI certification, CC-Link provides an open device level network with enhanced flexibility in system design and configuration.

- Maximum 10Mbps high-speed communication
- Link device remote I/O points: 8192 Remote register: 2048 + 2048 points
- Integrate other 3rd party manufacturers into the Q series system

Sensor level network CC-Link/LT
 At the lowest hierarchical network level, sensor level networks can still reduce wiring costs inside panels between simple discrete devices such as push-buttons and some sensors. Q series fully supports this with the sensor level version of CC-Link, CC-Link/LT. This new addition to the CC-Link family includes tremendous flexibility and cost savings through its innovative connection technology, which does not require cutting/stripping of the network cable to make connections.

- Easy connections with dedicated connectors
- Use I/O points effectively by incorporating number of points mode (4 points, 8 points, 16 points).
- The maximum number of link points is 1024 points in the 16-point mode.

MELSECNET/H PC interface cards

Q series provides the capability to include generic PCs on the MELSECNET/H network via a wide range of PCI interface cards. The software drivers included with these cards allow system integration of 3rd party systems, while also maintaining compatibility with existing MELSECNET/H installations. Including extensive RAS functions for error detection. An external power supply board is also available.

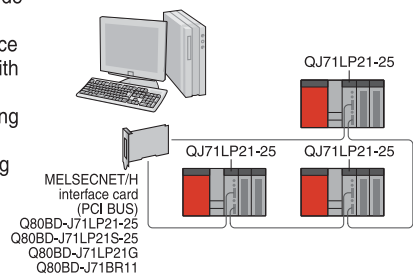

MELSECNET/H Remote I/O Network

MELSECNET/H offers the capability to locate remote bases containing Q series I/O modules on a 25Mbit control level network. The key benefit of this is that complex distributed I/O systems can be built using the same I/O modules as the controller itself. Hence systems that need more than distributed I/O blocks on a network can be addressed with Q Series. Any other station on the network can be accessed from each remote I/O station. In addition, by incorporating the process CPU, redundant remote I/O systems can be realized by using MELSECNET/H master and standby master stations.

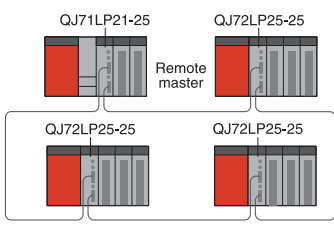

CC-Link master/local interface board for personal computer

Personal computer master/local interface boards are available with CC-Link. Previously, the master and local boards were separate items, but a single board can now be set to serve as either a master or local board, thereby increasing the range of field network control applications with regard to direct control, monitoring, and management, etc.

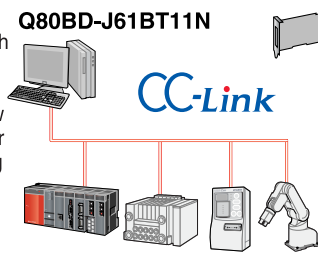



Ensures optimal information collection in any environment.

The optimal Ethernet interface module can be selected for the system and other devices in question.

- Ethernet Interface module for 10BASE-T/100BASE-TX ... **QJ71E71-100**
- Ethernet Interface module for 10BASE-5 **QJ71E71-B5**
- Ethernet Interface module for 10BASE-2 **QJ71E71-B2**

Features

1. 100BASE-TX support enables faster transmission speeds. (QJ71E71-100)
2. Uses dedicated instructions for communication between PLC CPUs.
3. PLC devices can be accessed from the web browser of a personal computer, using the HTTP protocol. The communication library and sample screens that run on the personal computer (web) can be obtained from the download service.
4. Multiple modules can be connected to GX Developer for better debugging efficiency.
5. E-mail texts (ASCII format) and attached files (binary / ASCII / CSV formats) can be transmitted.
6. KeepAlive can be used to perform existence checks (existence confirmation function) versus other devices in order to detect closed connections due to other-device errors, etc.

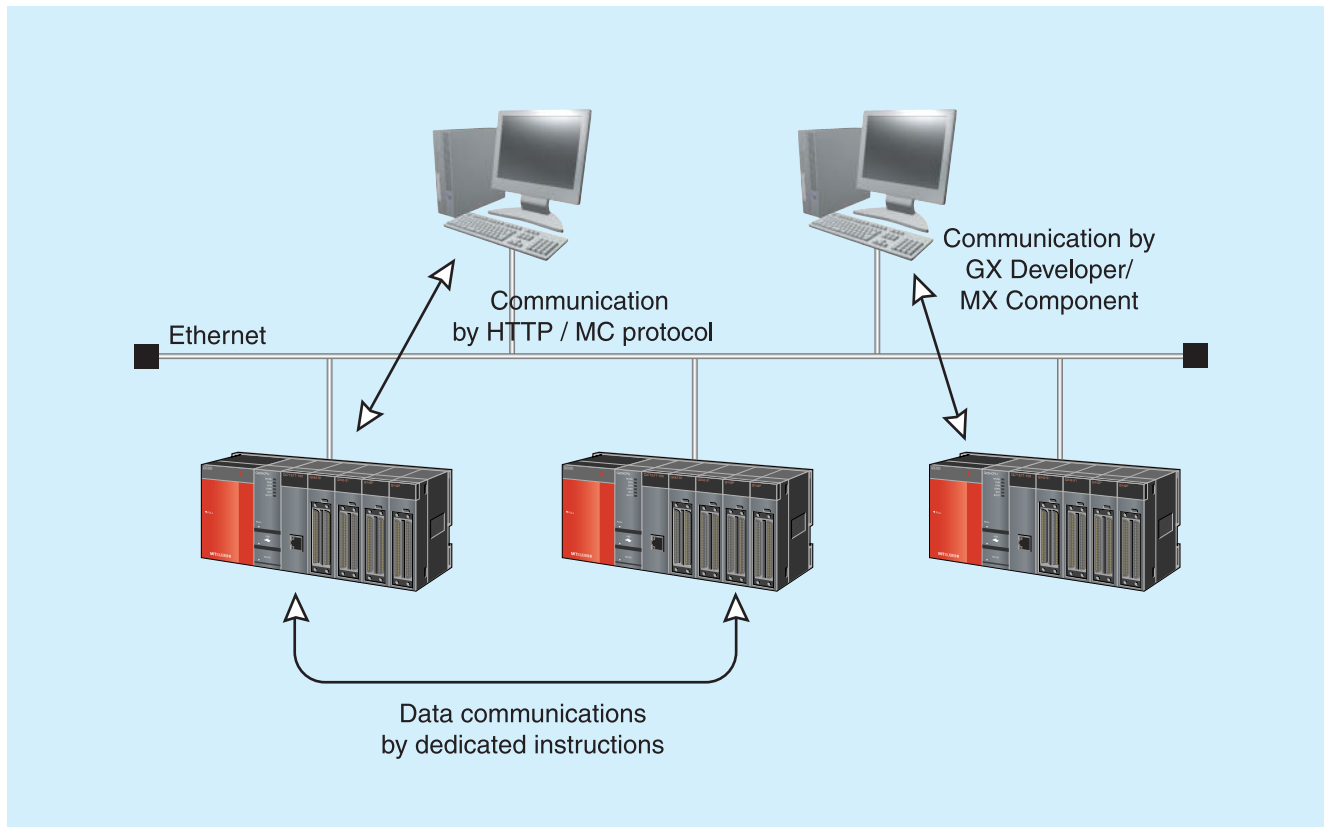

Communication module for PLC data collection/editing, monitoring/managing, and measurement data collection.

- Serial communication module ... **QJ71C24N (RS-232 1ch, RS-422/485 1ch)**
QJ71C24N-R2 (RS-232 2ch)
QJ71C24N-R4 (RS422/485 2ch)

Features

1. High-speed and high-capacity communication: baud rates up to 230.4kbps, with a capacity of 960 words (when using MC communication protocol).
2. Reading and writing of PLC data can be performed from an external device (personal computer, display device, etc.), using the MC protocol.
3. Communication by non-procedural protocol is possible to permit data exchanges between the PLC and an external device (barcode reader, measurement device, etc.) using a communication protocol specified by the external device. (Requires a communication sequence program.)
4. PLC programming and monitoring can be performed from GX Developer, using the QJ71C24N(-R2) RS-232 serial communication function.
5. QJ71C24N(-R2) supports public telephone line modems, allowing it to initialize the employed modem and connect to other devices in order to communicate with remote devices or GX Developer by way of the modem and public telephone line. A remote password function prevents unauthorized access to Q-Series PLCs via the modem being used by QJ71C24N(-R2).

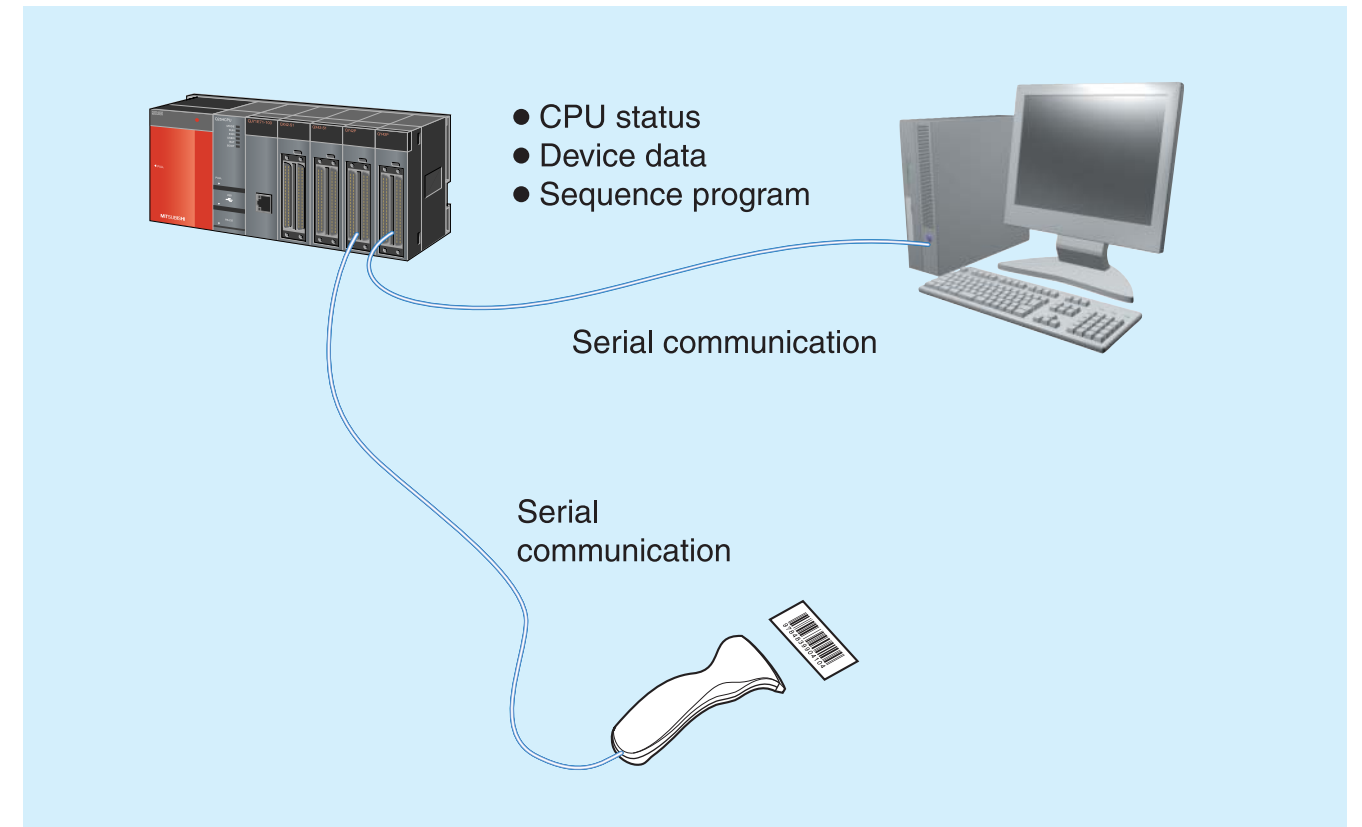



Constructing a highly-reliable network with redundant master stations

Multiplex remote station

By providing a multiplex remote master station and multiplex remote sub-master station on one remote I/O network, the remote I/O network can be controlled by the multiplex remote sub-master station even if the multiplex remote master station's PLC CPU fails. Provisions for failure of the multiplex remote sub-master station can also be taken by returning the multiplex remote master station during control of the remote I/O network with the multiplex remote sub-master station.

System configuration

- Redundant system comprised of QnPHCPU + MELSECNET/H remote I/O network.
- Even if the multiplex remote master station fails due to a system error, such as cutoff of the remote master station's power, the multiplex remote sub-master station continues I/O operation with the multiplex remote function.

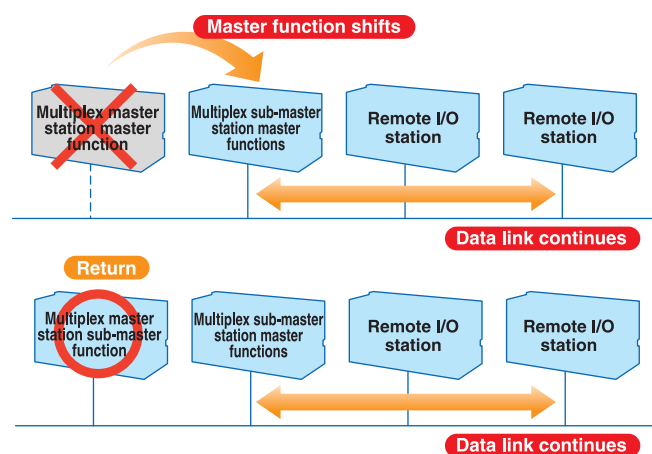
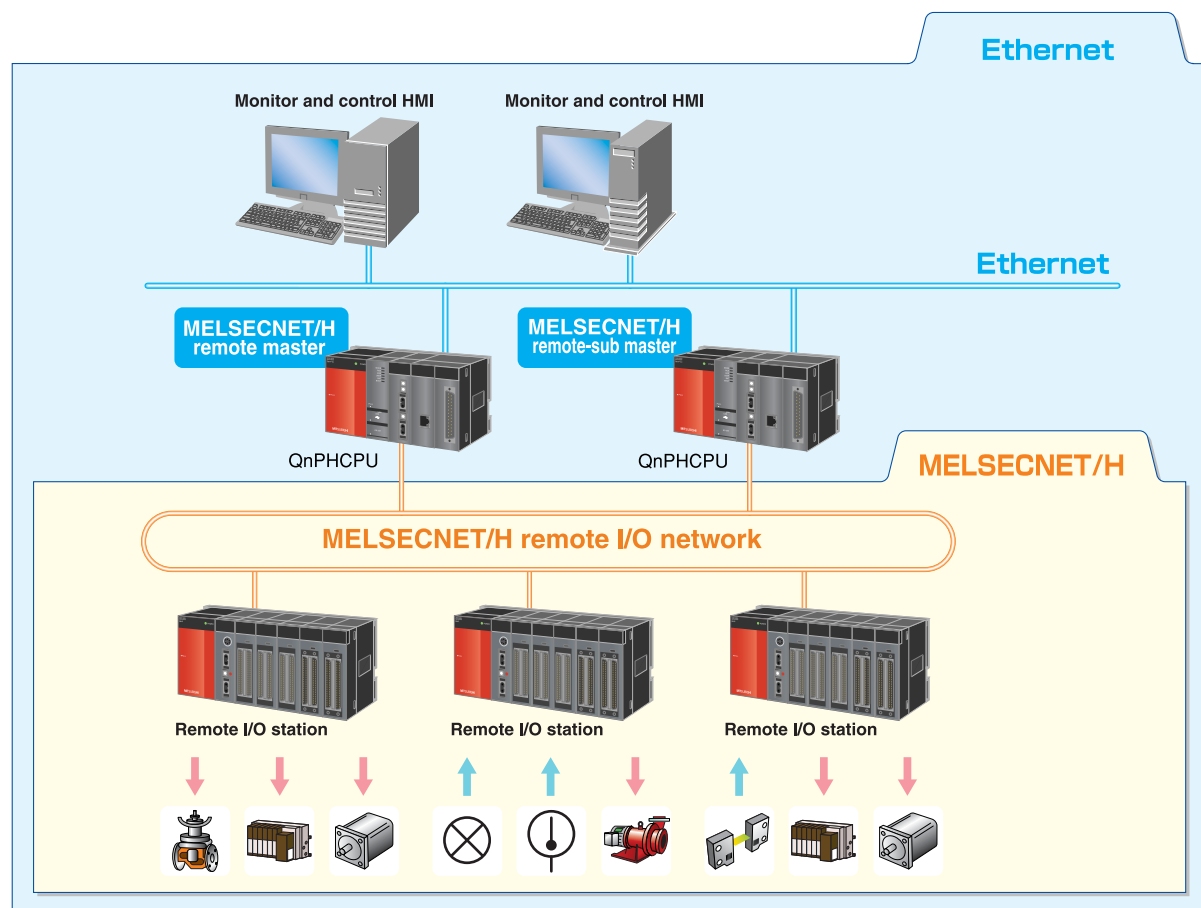

CC-Link redundant system

Data links are continued by automatically switching to the standby master station (station for master station backup) when a master station error occurs as the result of an error in the PLC CPU or power supply, etc. The master station can be returned even during data link control with the standby master station as a provision should the standby master station fail.

System configuration

Construct a redundant system with CC-Link network regardless of the master station or standby master station's CPU type.

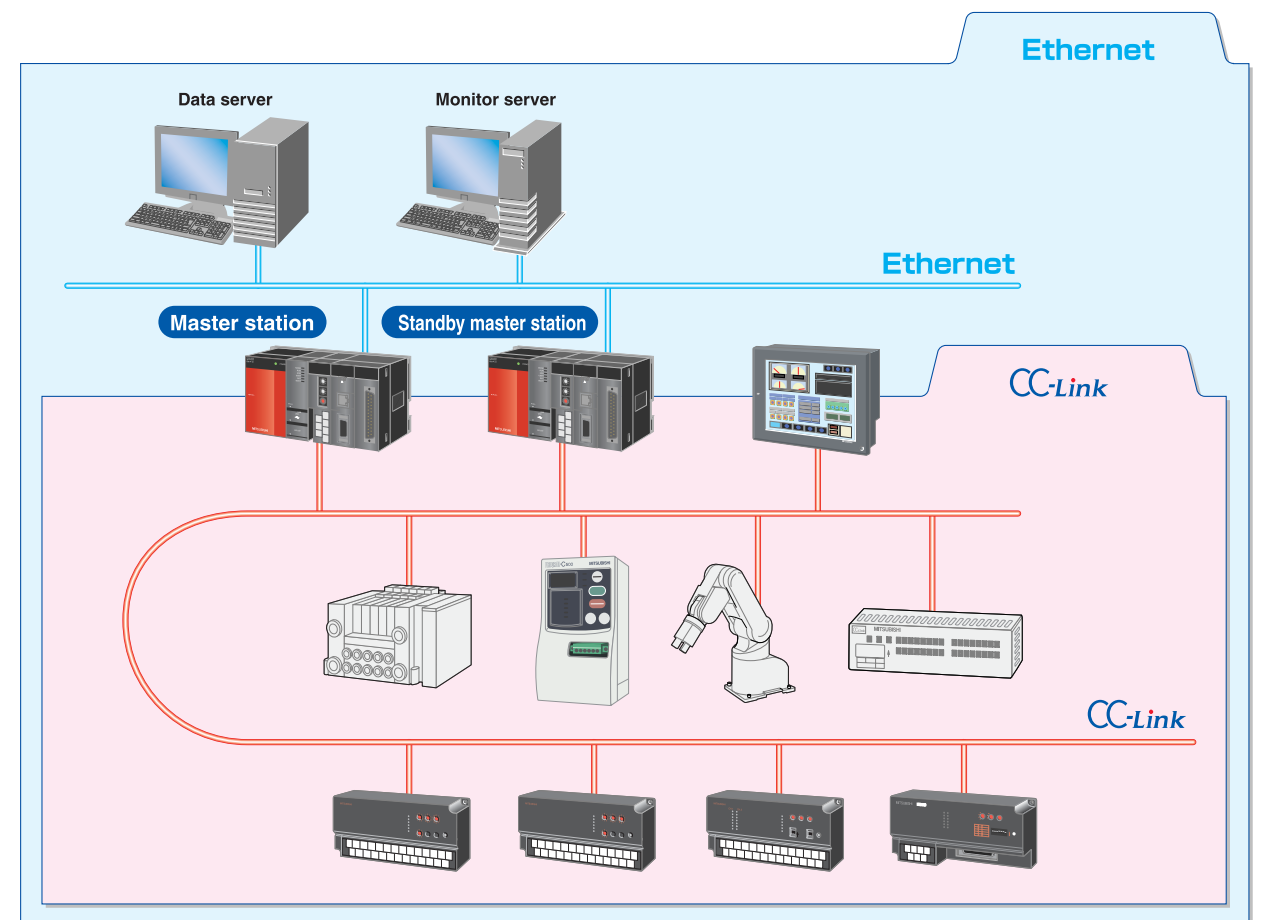

By using the CC-Link master station redundant system, the standby master station continues the data link when the master station fails. If a data link is established for the standby master station, the master station can be returned as the standby master station.

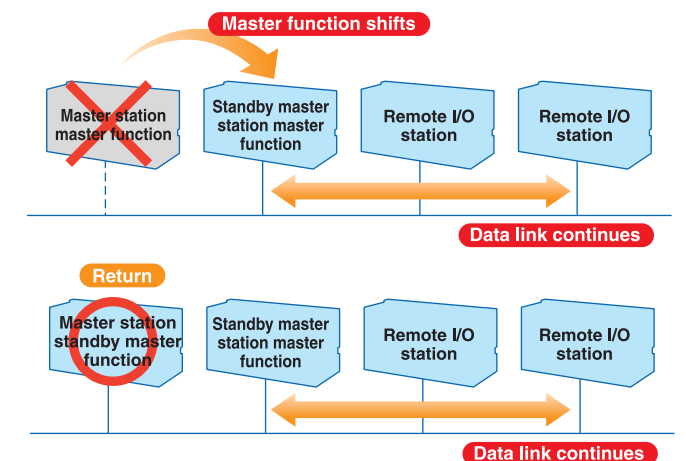



Intelligent & High Functionality

Intelligently handling advanced control functions

Comprehensive range of I/O and intelligent function modules.

Q series includes a comprehensive range of I/O and intelligent function modules to meet the needs of a diverse range of applications. As well as standard digital and analog I/O types (including channel-isolated analog), also available are motion control, serial communications, temperature controllers, temperature inputs, etc. Therefore realizing a solution ideal for the application, be it high speed positioning or highly accurate temperature control.

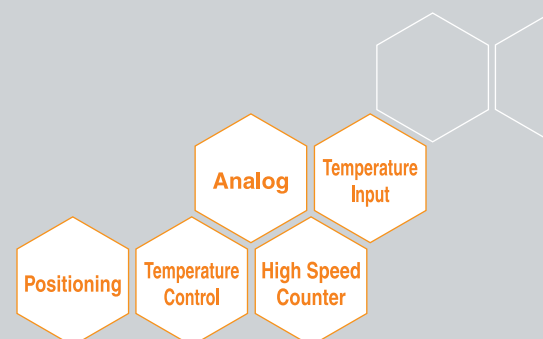

Assorted function modules to match every control application.



Analog Module

Analog to Digital Converter Modules

- **Channel-isolated type**
 - G64AD-GH** • 4ch • Voltage/current input
 - G62AD-DGH** • 2ch • Distributor module
- **Channel non-isolated type**
 - Q64AD** • 4ch • Voltage/current input
 - Q68ADV** • 8ch • Voltage input
 - Q68ADI** • 8ch • Current input

Digital to Analog Converter Modules

- **Channel-isolated type**
 - Q62DA-FG** • 2ch • Voltage/current output (With output monitor)
- **Channel non-isolated type**
 - Q62DA** • 2ch • Voltage/current output
 - Q64DA** • 4ch • Voltage/current output
 - Q68DAV** • 8ch • Voltage output
 - Q68DAI** • 8ch • Current output
- **External power supply and analog output isolation type (non-isolated channels)**
 - Q62DAN** • 2ch • Voltage/current output
 - Q64DAN** • 4ch • Voltage/current output
 - Q68DAVN** • 8ch • Voltage output
 - Q62DAIN** • 8ch • Current output
- **Loop control module**
 - Q62HLC** • 2ch input • 2ch output



Temperature Control Module

- Q64TCTT** • 4ch • Thermocouple input • transistor output
- Q64TCTTBW** • 4ch • Thermocouple input • transistor output, with wire break detection function
- Q64TCRT** • 4ch • Platinum temperature-measuring resistor input (3-wire type) • transistor output
- Q64TCRTBW** • 4ch • Platinum temperature-measuring resistor input (3-wire type) • transistor output, with wire break detection function



Temperature Input Module

- **Channel-isolated type**
 - Q64TDV-GH** • 4ch • Thermocouple input/Micro voltage input
 - Q64TD** • 4ch • Thermocouple input
 - Q64RD-G** • 4ch • Platinum-nickel temperature-measuring resistor input (3/4-wire type)
- **Channel non-isolated type**
 - Q64RD** • 4ch • Platinum temperature-measuring resistor input (3/4-wire type)



Positioning Module

- **Open collector output type**
 - QD70P4** • 4 axes • 200Kpps • Positioning data: 10 data points/axis
 - QD70P8** • 8 axes • 200Kpps • Positioning data: 10 data points/axis
 - QD75P1** • 1 axis • 200Kpps • Positioning data: 600 data points/axis
 - QD75P2** • 2 axes • 200Kpps • Positioning data: 600 data points/axis
 - QD75P4** • 4 axes • 200Kpps • Positioning data: 600 data points/axis
- **Differential driver output type**
 - QD70D4** • 4 axes • 4Mpps • Positioning data: 10 data points/axis
 - QD70D8** • 8 axes • 4Mpps • Positioning data: 10 data points/axis
 - QD75D1** • 1 axis • 1Mpps • Positioning data: 600 data points/axis
 - QD75D2** • 2 axes • 1Mpps • Positioning data: 600 data points/axis
 - QD75D4** • 4 axes • 1Mpps • Positioning data: 600 data points/axis
- **SSCNETIII connection type**
 - QD75MH1** • 1 axis • Positioning data: 600 data points/axis
 - QD75MH2** • 2 axes • Positioning data: 600 data points/axis
 - QD75MH4** • 4 axes • Positioning data: 600 data points/axis
- **SSCNET connection type**
 - QD75M1** • 1 axis • Positioning data: 600 data points/axis
 - QD75M2** • 2 axes • Positioning data: 600 data points/axis
 - QD75M4** • 4 axes • Positioning data: 600 data points/axis



Channel-Isolated Pulse Input Module

- QD60P8-G** • 8ch • 30Kpps • 5/12 to 24 VDC input • With pre-scale function



High Speed Counter Module

- QD62** • 2ch • 200Kpps • 5/12/24 VDC input • Transistor output (sink)
- QD62D** • 2ch • 500Kpps • Differential driver input • Transistor output (sink)
- QD62E** • 2ch • 200Kpps • 5/12/24 VDC input • Transistor output (source)



Interrupt Module

- QI60** • 24 VDC input 16 points



Input Module

- Selectable high-speed/low-speed and input response time for DC input module.



Output Module

- Some types of transistor output modules include short-circuit protection.

[Partner product] _____
● GP-IB module

Refer to pages 45 to 46 for details on the partner product.



A wide range of application specific intelligent modules

A range of analog modules ideal for process control applications.

Optimum isolated analog modules for process control

- Channel-Isolated High Resolution A/D Module **Q64AD-GH**
- Channel-Isolated High Resolution A/D Module (With Signal Conditioning function) **Q62AD-DGH**
- Channel-Isolated High Resolution D/A module **Q62DA-FG**

The channel-isolated analog modules are specifically designed for process control applications by offering high accuracy conversion combined with high isolation voltage. Flowmeter, pressure gauge, etc can be directly connected to the analog input, and control valve to the analog output. Also, hardware and installation costs are substantially reduced because an external isolation amplifier is no longer required. Used together with a general purpose controller, a low cost process control solution is easily realized.

System configuration example

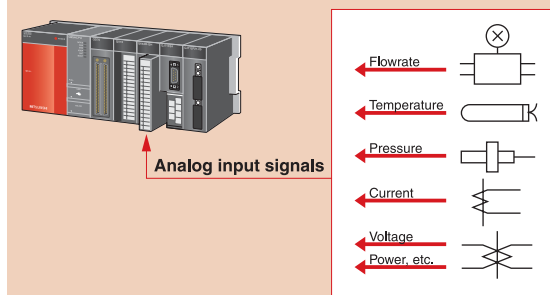

Analog modules for control applications that require high speed conversion.

- A/D module **Q64AD, Q68ADV, Q68ADI**
- D/A module **Q62DA, Q64DA, Q68DAV, Q68DAI**

A diverse range of analog modules are available for both A/D and D/A conversion. These high-speed conversion modules are suited for connection to various automation products, such as servo amplifiers and inverters, therefore providing a highly accurate solution.

System configuration example

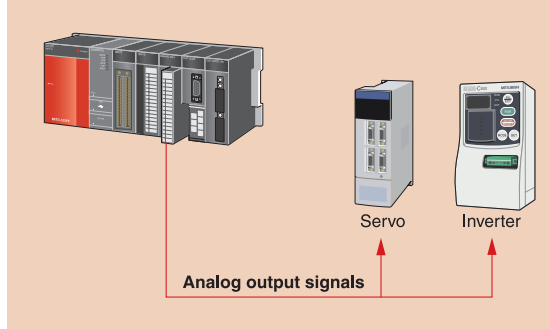

The analog module is ideal for control environments requiring superior anti-noise and safety levels

- D/A module **Q62DAN, Q64DAN, Q68DAVN, Q68DAIN**

Isolating the analog output channel from the external power supply will permit stable analog outputs even if noise occurs. This isolation will also improve operation stability and prevent module internal failures caused by incorrect wiring.

System configuration example

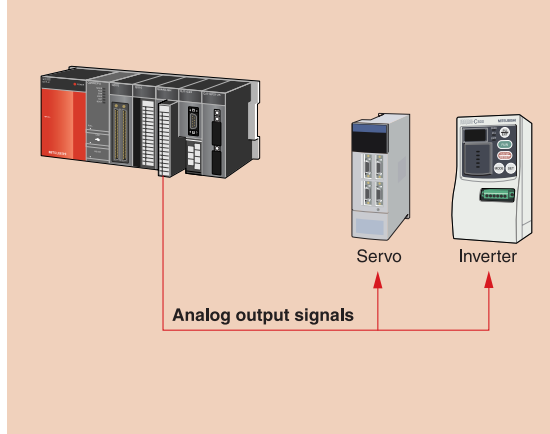

Temperature control modules that realize PID loop control.

- Temperature control module ... **Q64TCTT (BW), Q64TCRT (BW)**

Q Series offers a range of dedicated PID temperature loop controllers. These modules include their own PID control loops that act independently of the main CPUs. This allows a system to realize higher performance by diverting some control tasks from the main processor(s), freeing them up to take care of other control tasks. The temperature control modules offer compatibility with thermocouples and RTDs. A broken wire detection feature is also available.

System configuration example

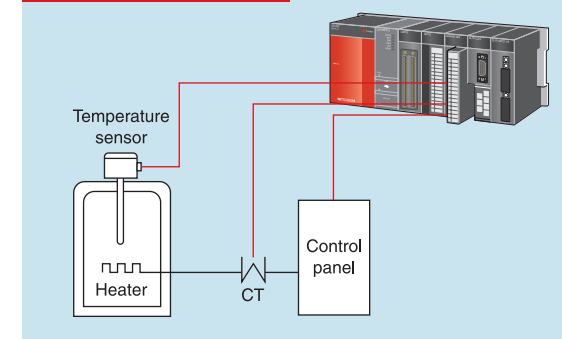

High accurate temperature input modules

- Channel-isolated thermocouple input module **Q64TDV-GH**
(Thermocouple input, micro voltage input)
- Channel-isolated temperature-measuring resistor input module **Q64RD-G**
(Platinum temperature-measuring resistor input, nickel temperature-measuring resistor input)
- Temperature-measuring resistor input module **Q64RD**
(Platinum temperature-measuring resistor input)

Realize temperature data input by connecting a thermocouple, and platinum temperature-measuring resistor or nickel temperature-measuring resistor. Initial settings and the automatic refresh settings can be set using GX Configurator -T1 (Temperature input unit setting monitor tool), reducing the program.

System configuration example

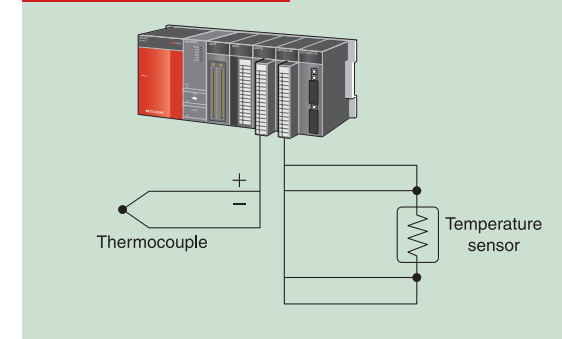

The loop control module is ideal for temperature and flow rate control environments which require fast response

- Loop control module **Q62HLC** **NEW**

With its speed-proportional PID control format and 25ms sampling cycle, the loop control module is well suited for high-precision, high-resolution thermocouple inputs, weak voltage inputs, voltage inputs, current inputs, and current outputs. It is also ideal for sudden temperature change control, pressure control, and flow control applications which require fast response.

- Connectable to JIS, IEC, NBS, ASTM standards compliant thermocouples.
- Permits analog value measurements of various input ranges by using weak voltage, voltage, and current input sensors.
- Offers program control while automatically changing the target values (SV) and PID constants [proportional zone (P), integral time (I), derivative time (D)] in a time-specific manner, as well as a cascade control function that permits control with CH1 as the master, and CH2 as the slave.

System configuration example

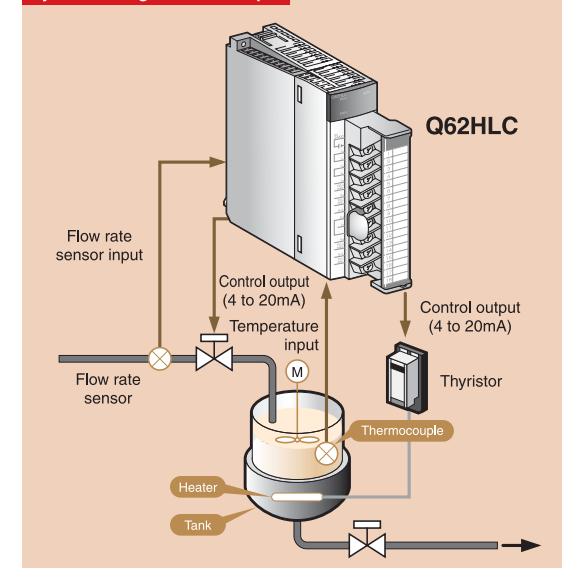



Diverse range of motion control solutions offering compatibility with any drive system.

High speed and accurate positioning control

Various positioning control is supported including 2 to 4-axis linear interpolation, 2-axis circular interpolation, speed control, speed/position changeover, path control and constant speed control. Together with GX Configurator-QP setup software, setting the positioning data, monitoring, and debugging are easier. Also, Q Series leverages the benefits of SSCNET, Mitsubishi's high performance motion control network. This allows Mitsubishi's intelligent digital servos to be connected by a simple daisy chain cable, reducing costs and increasing performance.

SSCNETIII connection type

- High-speed serial communication SSCNET III connection type **QD75MH** NEW

An SSCNET III cable connection both minimizes the required wiring, and permits distances of up to 50m between stations. This format is also compatible with absolute position systems where the home position is established by a data setting type home position return operation. Inputs of upper/lower limit LS and proximity dog Nos. are also possible at the servo amplifier, greatly reducing the required wiring.

System configuration example

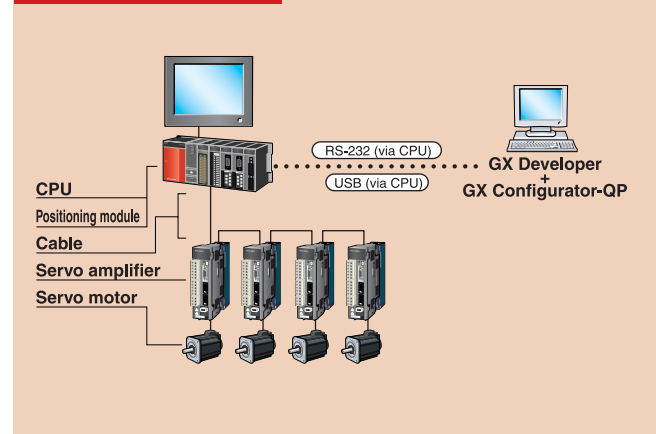

SSCNET connection type

- High-speed serial communication SSCNET connection type **QD75M**

Using the SSCNET cable connection, ensures wire saving with a maximum 30m cable length. This type is also compatible with the absolute position system which establishes the OP with the data set type OPR method. Wiring for the proximity dog, etc., is no longer required.

System configuration example

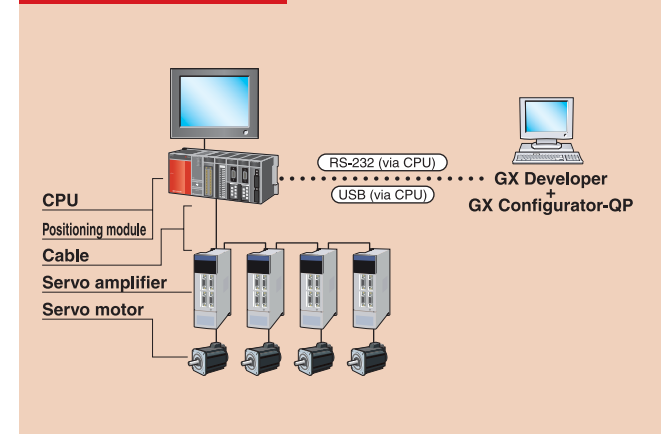

Application example 2 - Sealing

[Function]

- Constant speed pass control
- Linear, circular interpolation
- High-speed, high-accuracy pass control

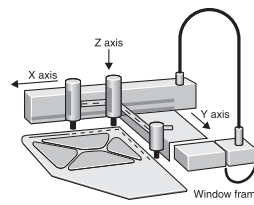
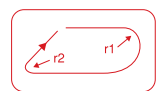

Pulse-train output type

- Differential driver pulse-train output type **QD75D**
- Open collector pulse-train output type **QD75P**

Both open collector and differential driver type positioning modules are available. The distance to the servo amplifier can be extended to 10m using the differential type, with a 1Mpps high-speed communication speed. High-speed, high-accuracy control are realized. (The command pulse with the open collector type is max. 200kpps.)

System configuration example

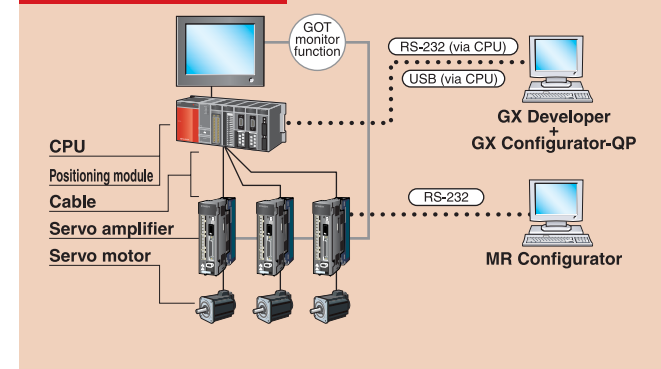

Application example - X-Y table control

[Function]

- 2-axis linear interpolation
- 3-axis linear interpolation
- 2-axis circular interpolation
- Constant speed pass control

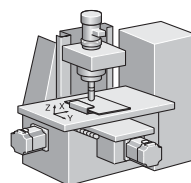

Ideal solution for simple multi-axis positioning systems

Satisfying requirements for simple positioning control applications, this module includes functions such as, positioning control, speed control, and variable positioning control. Here is the perfect positioning module for a multi-axis system that does not require complicated control.

- Open collector pulse train output type **QD70P**
- Differential output type **QD70D** COMING SOON

Control up to 4-axis/8-axis with one module.

Acceleration/deceleration is performed smoothly with very little speed fluctuations, therefore ideal for connecting to stepping motors.

High-speed processing is carried out at the start of position control.

	QD70P	QD70D
Pulse train output format	Open collector output	Differential output
Max. output pulses	200kpps	4Mpps
Max. connection distance between drive modules	2m	10m
Start time	1-axis start	0.1ms
	4-axis start *1	0.2ms
	8-axis start *1	0.4ms

*1: When START signal switches ON within 1 scan. There are no start delays between axes.

Application example

Stepping motor

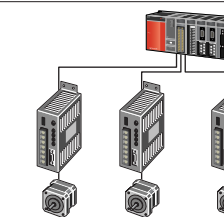

System configuration example

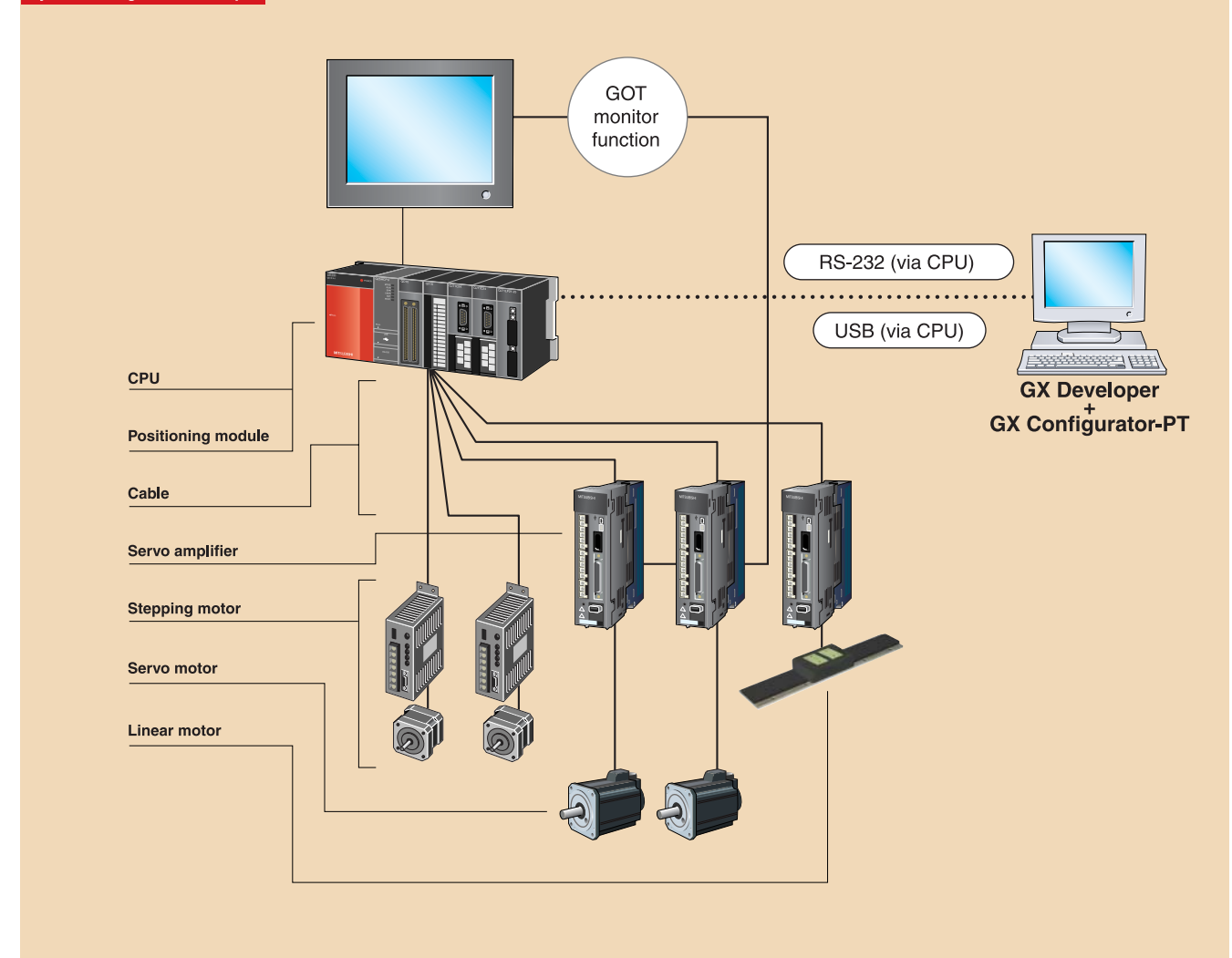



Comfortable and Easy - That's the comprehensive engineering

GX Series Totally supporting sequence control engineering.

The basic framework for GX Series and PX Developer

GX Developer

Improving development efficiency by supporting a diverse range of programming languages

A comprehensive suite of development, debugging and maintenance tools contained in one easy to use, fully Windows® compliant software package. GX Developer fully supports all Mitsubishi controllers, and offers a range of tools unique to Q Series.

A variety of programming options

With GX Developer, Q Series supports a range of programming options, including ladder diagram (LD), sequential function chart (SFC), structured text (ST), function block (FB) and instruction list (IL).

System monitor

Online system configuration monitoring and error detection of each module reduces the time taken for restoring systems due to errors occurring.



Network parameter settings

Network set up, such as Ethernet, MELSECNET/H, and CC-Link are easily done from the built-in parameters of GX Developer. Therefore, no need to produce separate network set up sequence programs.



Diagnostics

Built-in diagnostics tools for Ethernet, MELSECNET/H, CC-Link, and CC-Link/LT as standard in GX Developer. These tools greatly improve the task of debugging and maintenance of the network.

Ethernet diagnostics Monitor the Ethernet parameters, such as the IP address, error history, status per connection, LED status and e-mail information, etc.

Network diagnostics Monitor the MELSECNET/H network information, link information and communication information. Diagnostics for network and loop tests are also included.



CC-Link diagnostics Monitor the local station's data link status, operation status and link scan time, etc.

CC-Link/LT diagnostics Monitor the local station's data link status and operation status, etc.

GX Simulator

System simulation for offline development

GX Simulator acts as a controller within your PC that duplicates the actual hardware your application will run on. It allows you to develop and verify the operation of your programs without needing actual hardware. Hence development of new systems can be carried out independently of actual plant equipment, and operation can be assured before commissioning on the shop floor. Operation is transparent, and duplicates the operation of the actual controller. GX Simulator also includes tools for analysis of system operation, such as a built in chart recorder for capturing system events, etc.

GX Configurator / GX Converter

Add-on software to enhance GX Developer functionality

GX Configurator

Configure and monitor without a program

This software sets and monitors the data for various intelligent function modules. Initialization can be carried out without a program by adding this onto GX Developer.

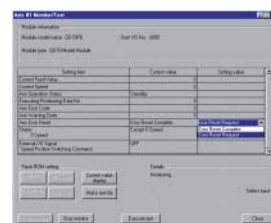

GX Converter

Simplifying document creation

GX Converter data conversion software package for Windows is a software designed to convert other format data (text format data, CSV format data) to GX Developer format data (instruction list, device comment). It allows CAD data to be utilized on GX Developer for equipment design or GX Developer data to be utilized for design on CAD, increasing design efficiency.

GX Explorer

Centralized, remote maintenance

GX Explorer allows multiple networked systems to be monitored and remotely maintained from a central location, using an intuitive Windows™ Explorer™ like interface. Network structures are represented, and programs can be uploaded and downloaded across the network links. Full access to all controller diagnostics is also available.



GX RemoteService - I

Remote maintenance made easy, incorporated into MELSOFT

When used together with GX Explorer, the various GX Explorer maintenance functions can be used via the internet or intranet. Therefore, used on a Windows® PC or the PC CPU, remote maintenance is realized easily and efficiently, providing another useful tool specific for the Q series.

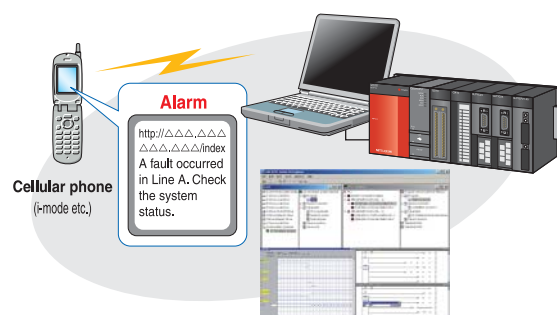

environment provided by MELSOFT.

MX Series Access to shop floor information in real-time.

MX Series provides a suite of middleware tools that abstract the different Mitsubishi hardware level protocols into a form that is easily integrated into third party applications. This allows you to build your own applications to work with the shop floor hardware without needing detailed knowledge of the internal functions of the controllers themselves. MX Series supports a variety of communication methods for maximum flexibility.

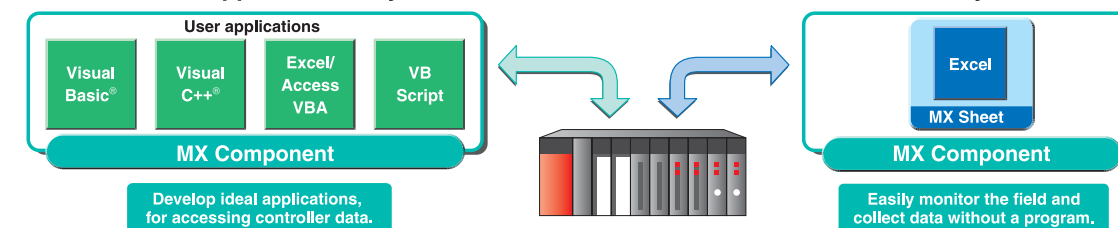

MX Component

ActiveX® based communications between a PC and the controller.

MX Component's ActiveX® based library frees the system programmer from having to consider low-level hardware based protocol communication issues when designing third party applications to interface with shop floor equipment. This shortens the design cycle, as development can leverage standard tools and concentrate on the system design itself.



MX Sheet

Collect data without programs.

A fully featured add-on software that easily integrates into Microsoft™ Excel™. Using together with this software, simple logging, monitoring, etc., functions can be realized as an alternative for a costly data acquisition software.

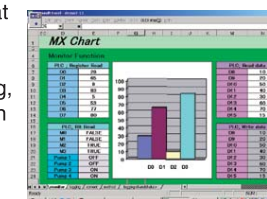

PX Developer A comprehensive process control system design tool with control and monitoring capabilities

PX Developer is dedicated to the Q process control CPUs. It provides a function block programming environment that meets the demands of process related applications. Built-in monitoring tools allow real time loop tuning and control.

Standard FB and dedicated process functions

- All Q Series process control related functions are represented by function blocks
- Custom FB can be created from standard blocks
- FB for accessing analog modules and input/output modules

Reuse program code on future projects

FBs make all programs modular, allowing immediate reuse in future projects requiring similar capabilities. This allows development time to be progressively shortened through the design lifetime.

Integration with sequence control programs

Using label based programming allows data from process control programs to be easily integrated into sequence control programs, further enhancing the integration of multiple processor systems.

Comprehensive system monitoring and control capability

The PX Developer Monitor Tool provides in-depth capabilities to provide real-time monitoring of loop functions combined with auto-tuning, cascade, automatic, and manual loop control options.

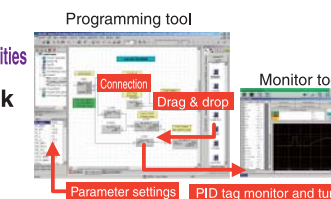

MT Developer Comprehensively supporting system structuring based on Motion controller.

A fully integrated program design software for the motion controller. This software includes many tools imperative for configuring and maintaining motion control systems, improving the overall design system.

Application specific programming environment

A diverse range of main OS software, ensures a flexible programming environment corresponding to the specific application requirements.



Maintenance and operation

Monitoring and diagnostics are further enhanced with the built-in parameter monitoring function, SFC monitoring and digital oscilloscope, errors can be resolved quickly and efficiently.

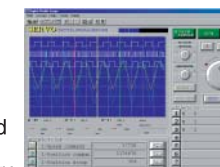

System test and debug

System startup time can be reduced with extensive system tests and program debugging tools.

MR Configurator General setting assistance for system servos.

This software offers servo setup-to-maintenance assistance. Monitoring, diagnosis, parameter writing/reading, and test operations can easily be performed from MR Configurator.

The ideal programming technique for the required application

Sequence Program Environment

Q Series supports all major sequence control programming methods in use today. These include Ladder Diagram (LD), Instruction List (IL), Sequential Function Chart (SFC), Function Blocks (FB) and Structured Text (ST). Additionally, the high performance Q Series sequence CPUs allow multiple programs to co-exist in the processor, and can be executed in variable ways, further improving the performance of the controller.

Manual operation program (Ladder (circuit representation))

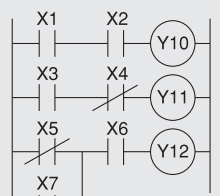

Communication processing program (Ladder (list representation))

```
LD X50
MOV P K1 D0
MOV P K4 D3
MOV P H3412 D10
MOV P HBC5A D11
MOV P HF0DE D12
MOV P H0A0D D13
GP.BIDOUT U8 DO D10 M0
```

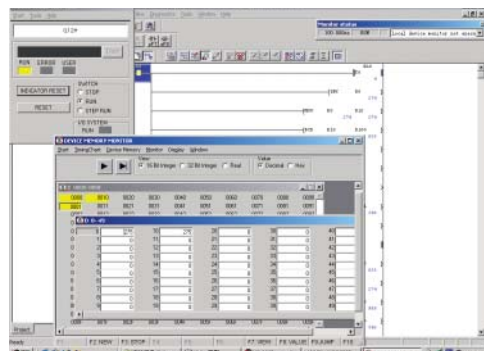

Program-free Initial Settings

GX Configurator frees the system designer from having to waste engineering time on writing and debugging code just to configure the controller's special function modules. All modules such as analog, communications and motion control have GX Configurator tools associated with them that reduce configuration to a simple menu based system. Further, the automatic refresh capability of the Q Series insures that using GX Configurator to monitor system configuration during maintenance always shows real time system data.

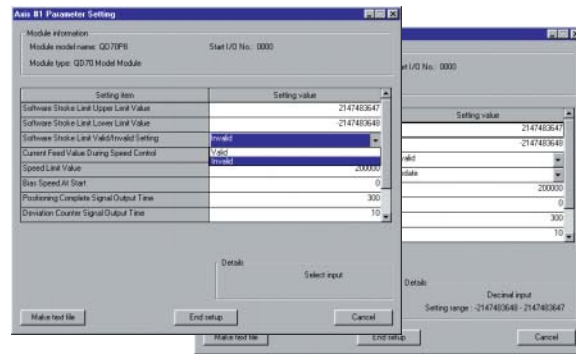

Sequential Function Chart Programming

Sequential Function Chart (SFC) is an industry standard programming method that improves the readability of a program via a graphical representation similar to a flowchart. Q Series fully supports SFC, offering you the chance to simplify the organization of your programming by using multiple program states to control and sequence the operation of your application. During maintenance, SFC can also be used to follow the operation of a system graphically, improving the productivity of maintenance personnel.

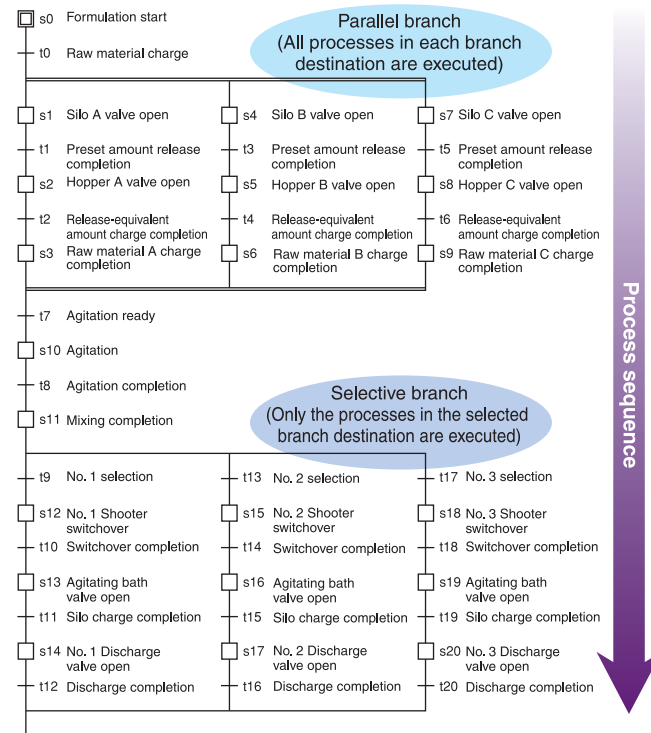

Fixed Scan Program

Q Series offers the ability to fix the program execution scan at a predetermined interval between 0.5ms-60s (High performance model QCPU, process CPU and redundant CPU). This allows the determinism of a system's execution to be improved for applications where execution timing is critical. To further improve response to brief events, a 0.2ms interrupt function is also available.

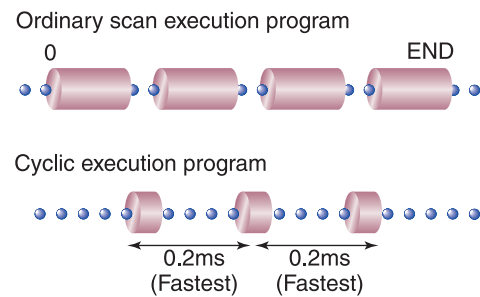

Function Blocks (FB)

Function blocks (FB) allow sections of programs to be represented as a single function block.

- Complex ladder programs can be made easier to read, simplifying debugging and troubleshooting on the shop floor.
- Program code can easily be reused by cutting and pasting function blocks.
- Use ladder diagram or structured text to create function block code.

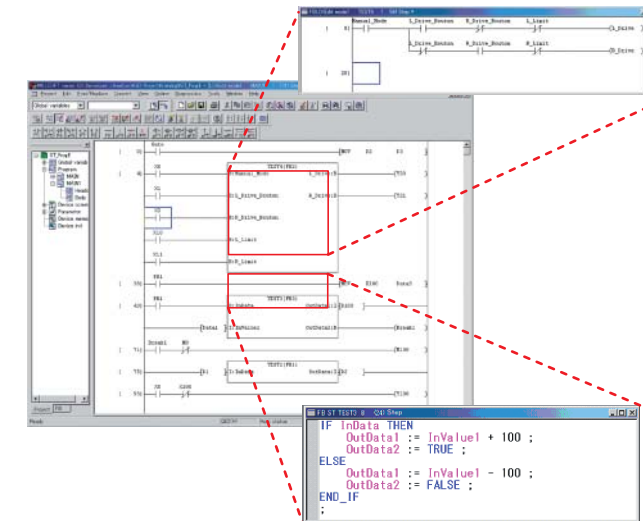

Process Control Function Block Diagram Programming

With the process CPU and redundant CPU, Q Series Process Control Function Block programs can be created by PX Developer. This allows easy creation and editing of loop control programs simply by dragging and dropping the required function blocks and connecting them together in the desired way. Loop parameters and other essential process properties can be easily configured. Process control programs can share data with sequence control program if label programming is used.

*GX Developer Ver. 7.20W or higher must be installed in the same personal computer to run PX Developer.

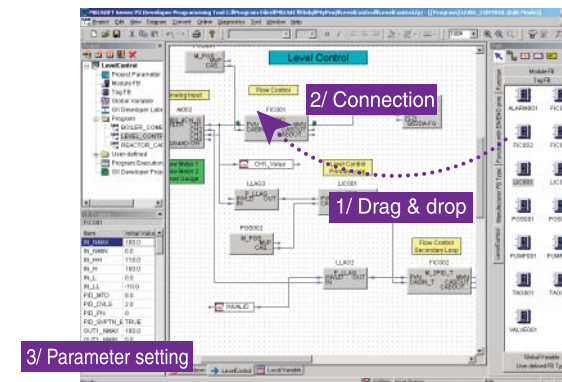

Structured Text (ST)

Structured text allows the Q Series to offer a new dimension in automation programming. ST breaks with the traditional methods of sequence programming by using a format similar to conventional computer programming languages. This offers the benefit of giving programmers a tool to describe processes that are not readily described using other languages. Additionally, ST offers newer programmers who are not familiar with automation in general an immediate opportunity to become productive based on their existing experience.

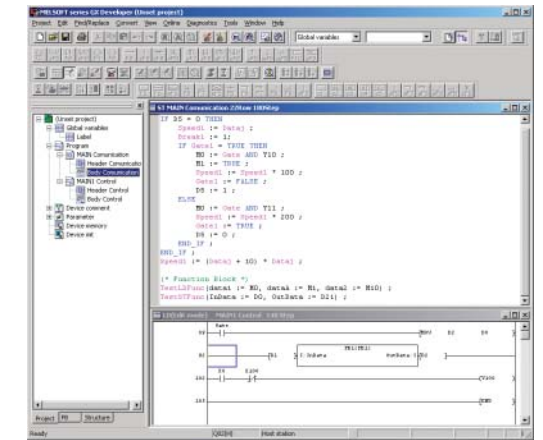

Remote Programming

GX Developer fully supports the remote maintenance of distant installations, whether via dial-up access or through the Internet to systems on the other side of the world. Once connected to a system, and security requirements are met, this type of connection allows full access to all aspects of the Q Series in the same way as a local connection via a programming cable.

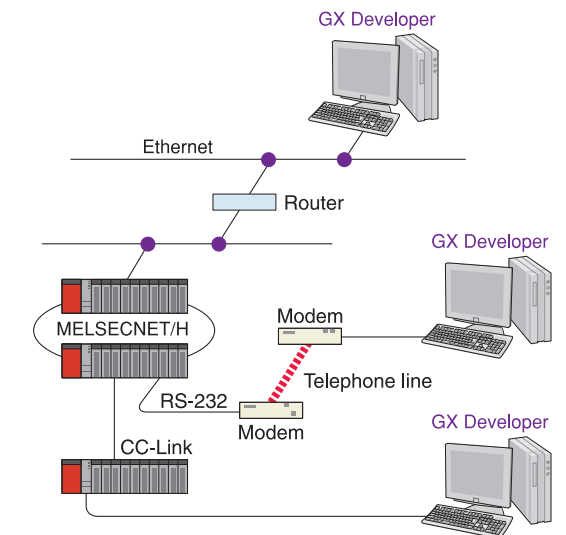



Working with the customer to provide the right solution



Realizing solutions for a diverse range of applications

A vast range of solutions available tackling the various challenges required in present and future applications.

The general trend of the manufacturing industry is requiring greater productivity with minimum cost, but still maintaining very high production quality. Such as the LCD and semiconductor industries, which requires larger sizes and greater diameter wafer sizes, whilst keeping the cost to a minimum. These trends are recognized and understood by Mitsubishi Electric, that is why the solutions provided are more than capable of reaching the stringent requirements. Therefore, together with Q series and other Mitsubishi Electric automation products, productivity and quality can be kept high, while keeping down costs.

- Semiconductor
- LCD
- Process Control
- Automotive
- Material Handling
- Food & Beverage
- Processing Plants, etc.

Semiconductor, LCD

- LED material packing machine ·PCB manufacturing line ·LCD manufacturing line ·Molding machine ·Mask device
- Spin coater ·Washer ·Inspection device ·Chemical supply unit ·Hard disk manufacturing ·Bump plating device
- CMP device ·Hard disk polisher ·Wafer polisher ·Exposure device ·Pure water processing device ·Splattering device ·Coating device ·CD inspection device ·Liquid crystal injection device ·Bonding

Process Control

- Food & Beverage (brewing, sterilization, drying) ·Chemicals (polymerization, distillation, drying) ·Fine chemicals (blending, mixing) ·Steel metals (ingredient mixing, sintering, reduction, separation) ·Non-ferrous metals (electric furnace, melting furnace) ·Water and sewage (dehydration, desulfurization, chemical injection) ·Paper manufacturing (paper machine) ·Environment (garbage incineration, ash treatment, drain, sludge treatment, pulverization, fuel cells) ·Semiconductors (heating furnace, diffusion furnace, ion injection) ·Ships (boiler) ·Plastic/rubber (winding) ·Buildings (air-conditioning, drainage, boiler)

Automotive

- Painting system ·Production specifications instruction system ·Engine conveyance device ·Vehicle assembly line
- Welding process ·Electric furnace heating device for crankshafts ·Disk brake machining ·Screw tightening error prevention system ·Automotive electronic part manufacturing

Material Handling

- Parcel sorting device ·PET bottle manufacturing and transfer line ·Household appliance distribution warehouse transfer line ·CRT transfer ·Woodworking machine conveyor ·NC loader ·Printed material transfer system ·Airport baggage handling system

Electric Devices

- Refrigerator manufacturing line ·Air conditioner manufacturing line ·Inverter manufacturing line

Chemicals

- Detergent packing line ·Rubber measurement ·Tire manufacturing device ·Synthetic leather manufacturing line
- Pre-processing for ceramics ·Polishing material measurement ·Concrete automatic measuring system

Food & Beverage

- Soft drink manufacturing line ·Food packaging machine

Printing

- Postcard printer ·Rotary press (offset/newspaper) ·Printer manufacturing line

Processing Plants

- Hydrogen booster ·Cardboard production facility ·Concrete manufacturing, filling device for tunnels

Press/moulding Machines

- Injection moulding machine-Extrusion machine

Buildings, Factories, Utility Control

- Building air conditioning system ·Power monitoring system ·Building security system-Building management system

Pharmaceutical

- Tablet manufacturing system

Various Devices and Systems

- Bearing manufacture ·Train car wheel inspection ·Microwave heating system

Providing the right solution for various applications

Beer brewery solution example
 Combining the Q series with other Mitsubishi Electric automation products to offer a powerful intelligent solution for your needs.

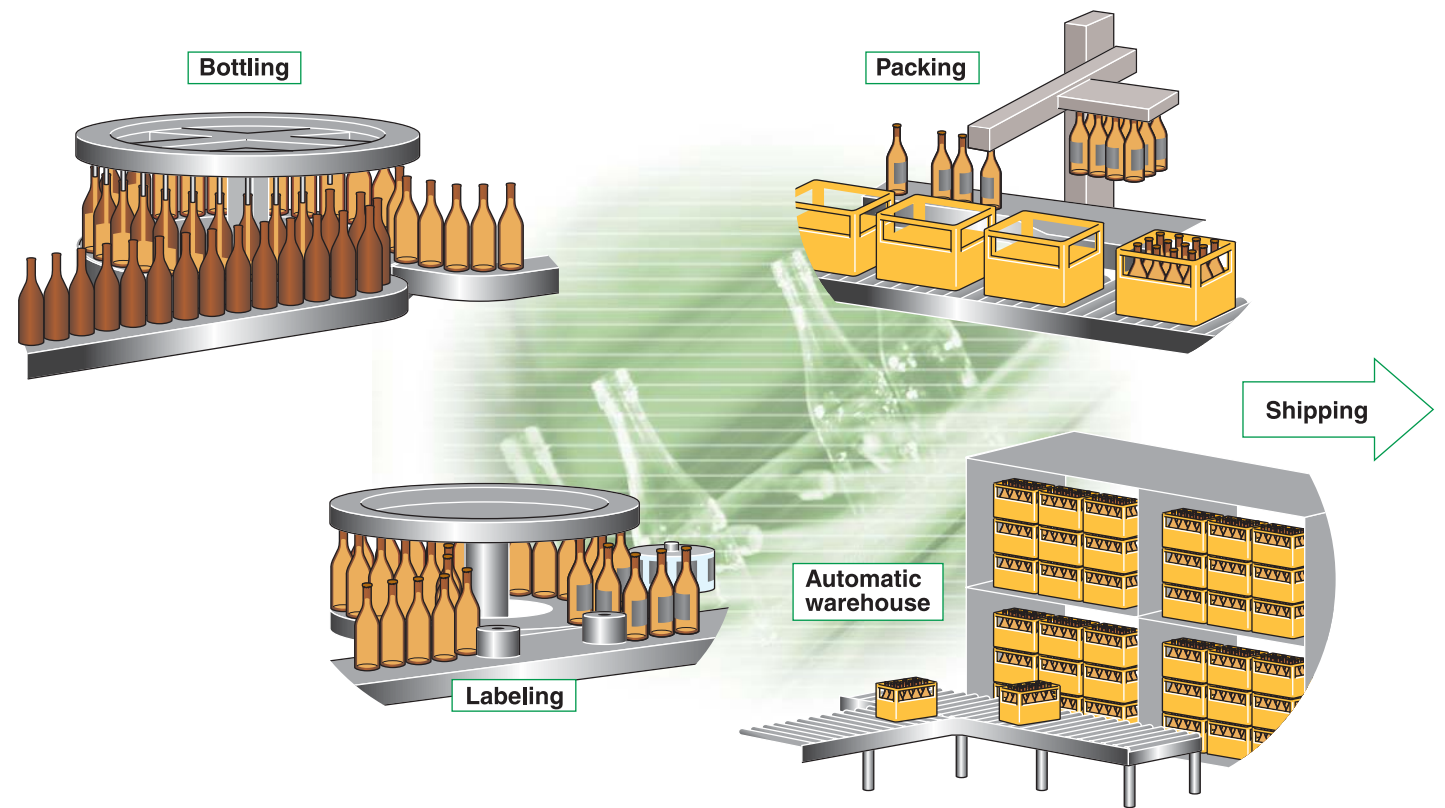
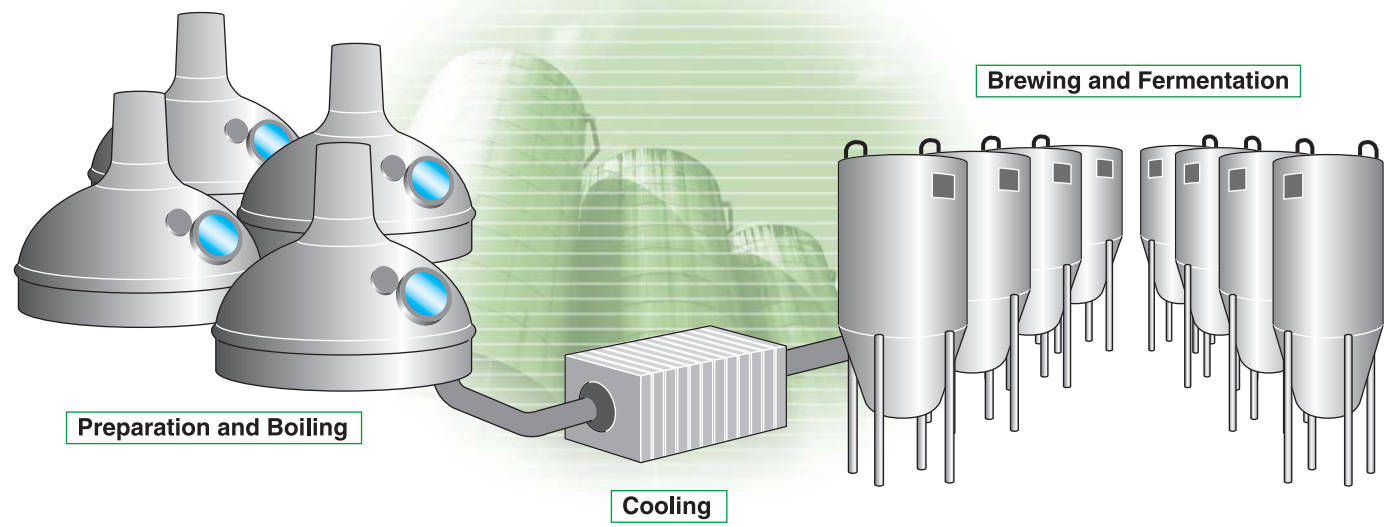

Temperature, flow rate and fluid level control

System configuration example

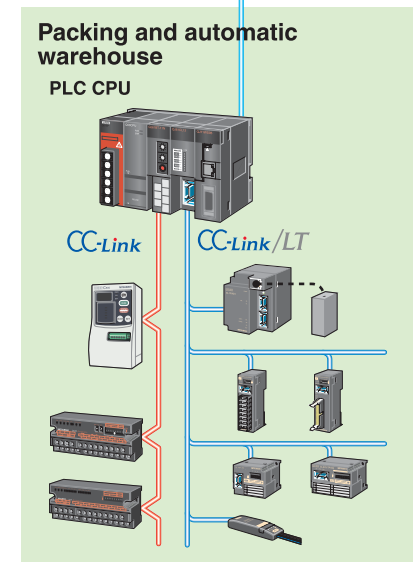
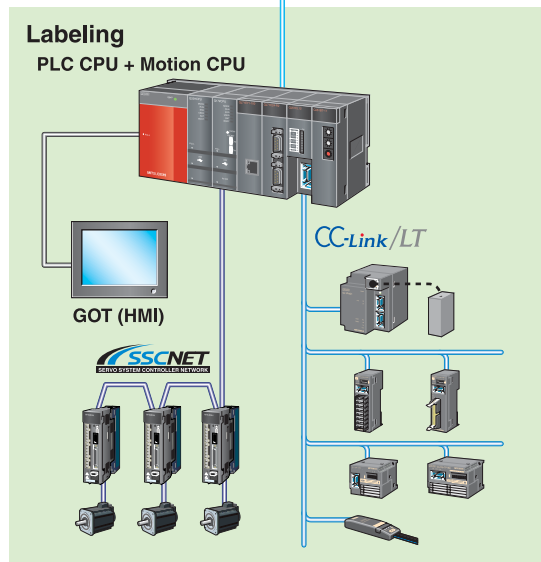
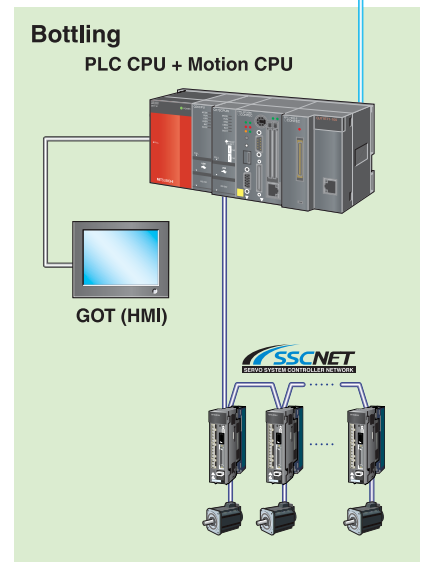
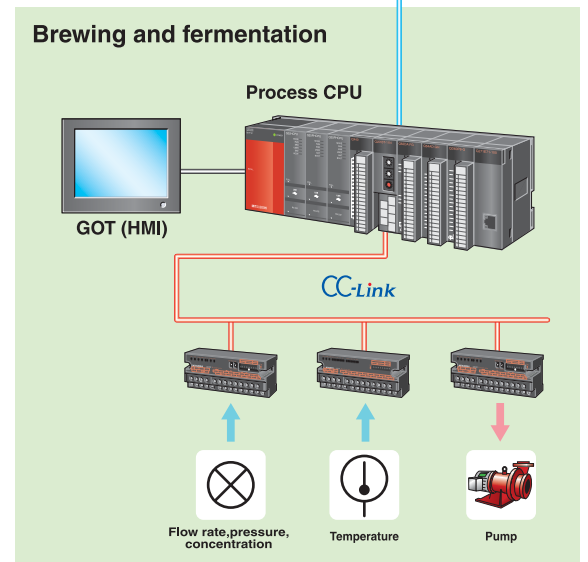
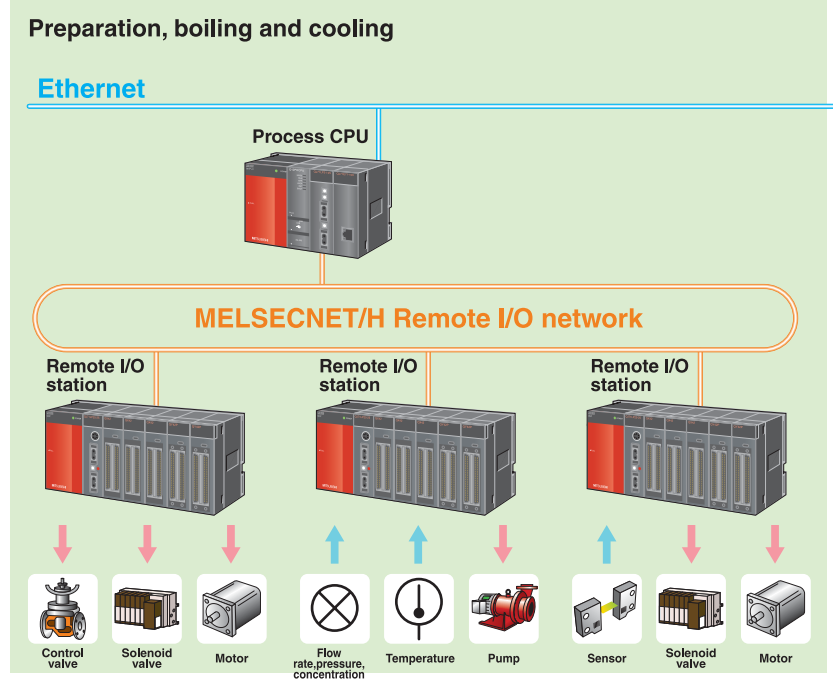



Providing solutions specific to the IT industry

Semiconductor (CMP system) solution example

Following the semiconductor industry's trend to 300mm technology

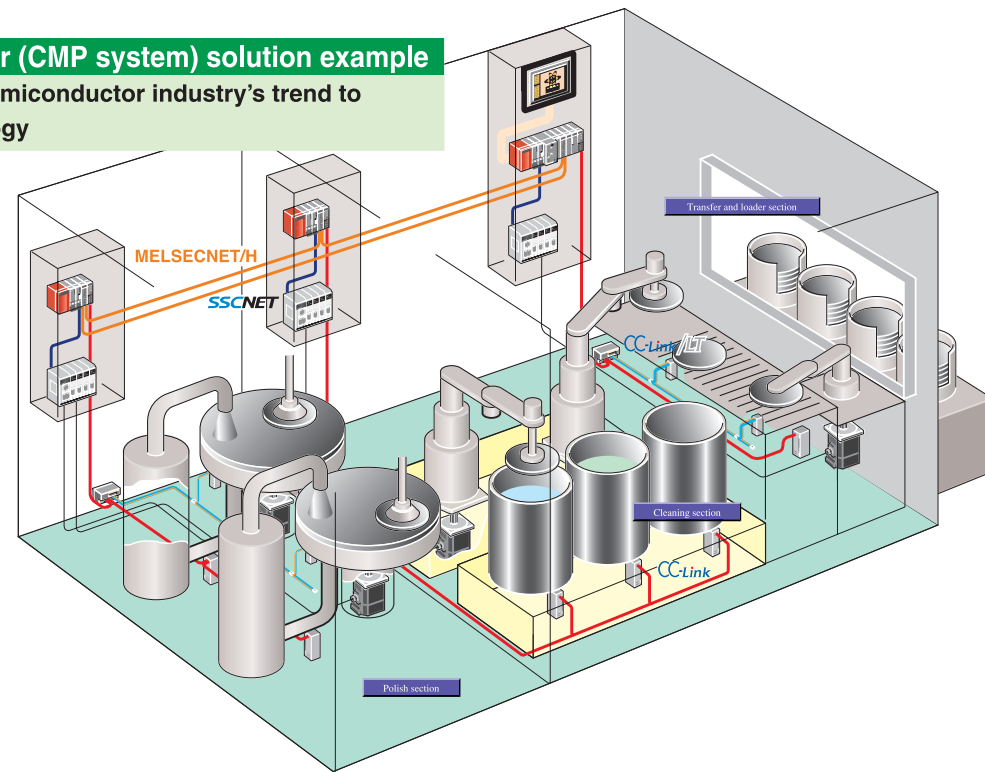

LCD (CVD system) solution example

Leading the manufacturing trends of LCD panels which continue to increase in size.

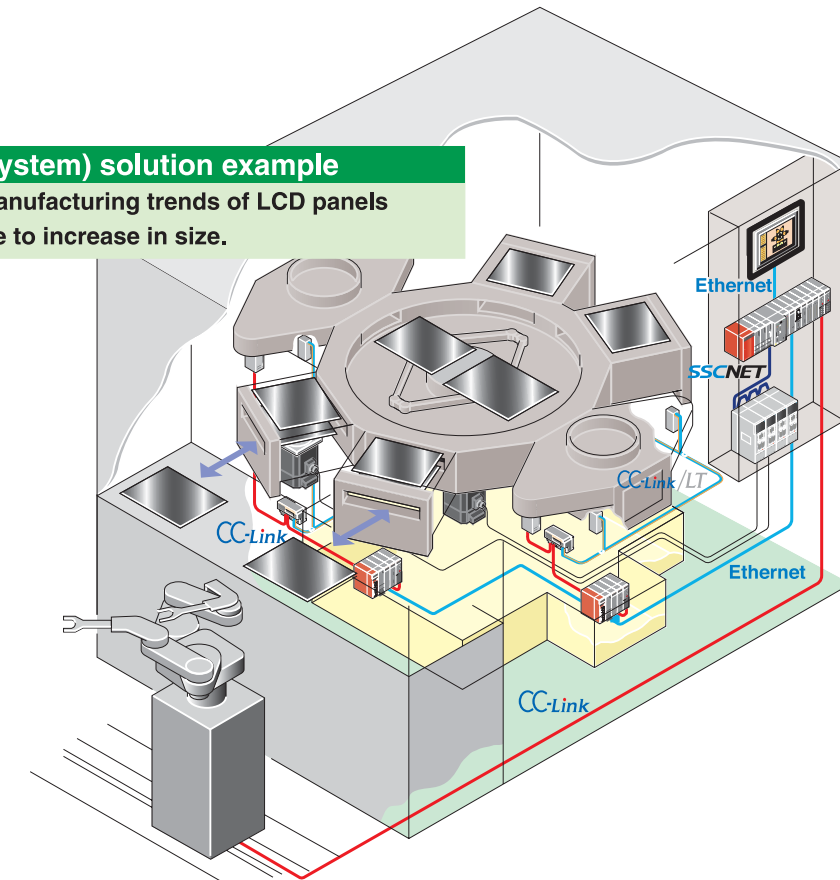

CMP system configuration example

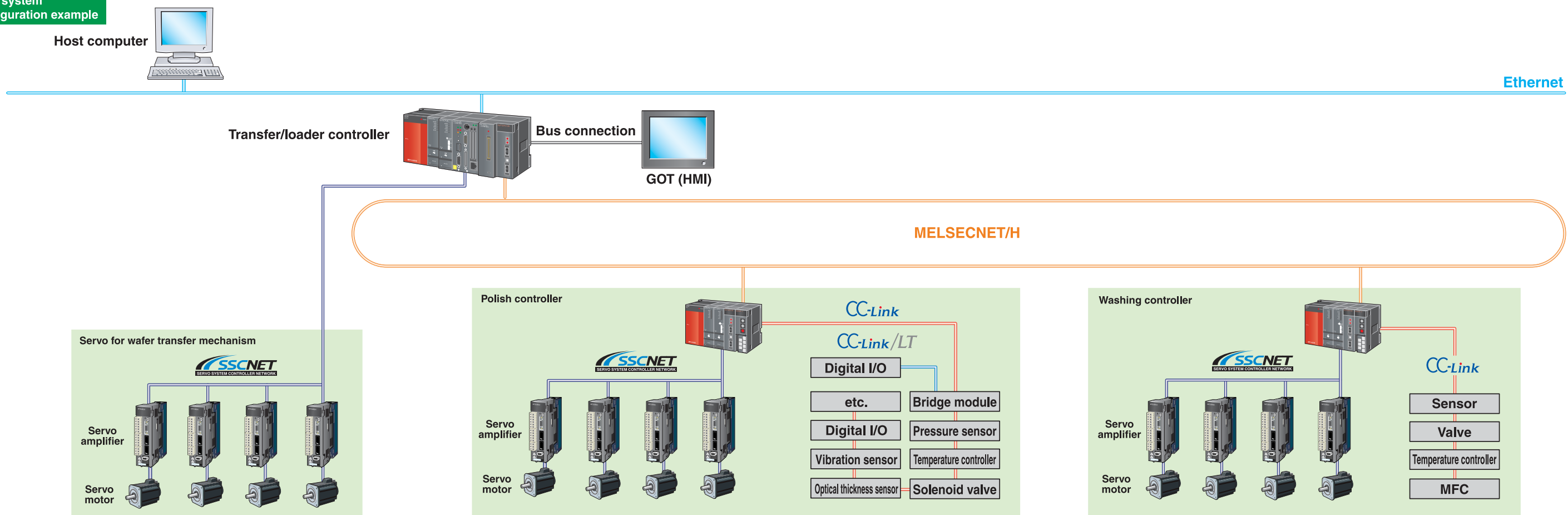



Powerfully supporting packaging solutions with accurate motion control

Horizontal packaging solution example

High feed rates with superior accuracy are realized.

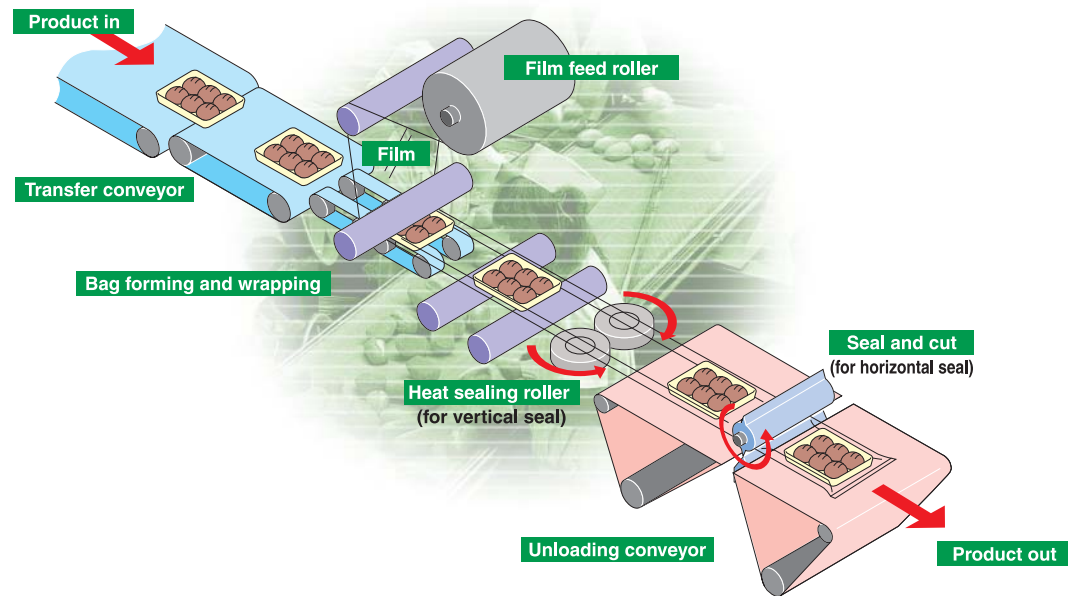

Horizontal packaging system configuration example

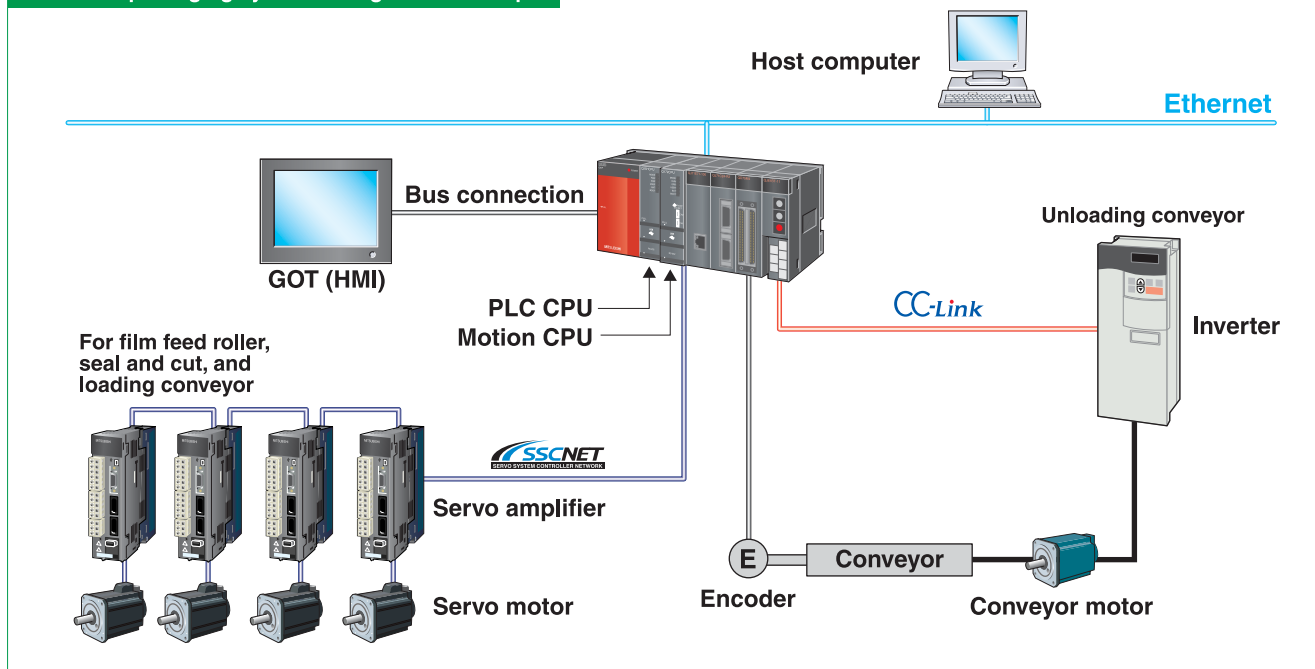

Providing worry-free solutions for continued operation even in the event of trouble.

Solutions for waste incineration

System failure is prevented with the redundant CPU, power supply, base and network.

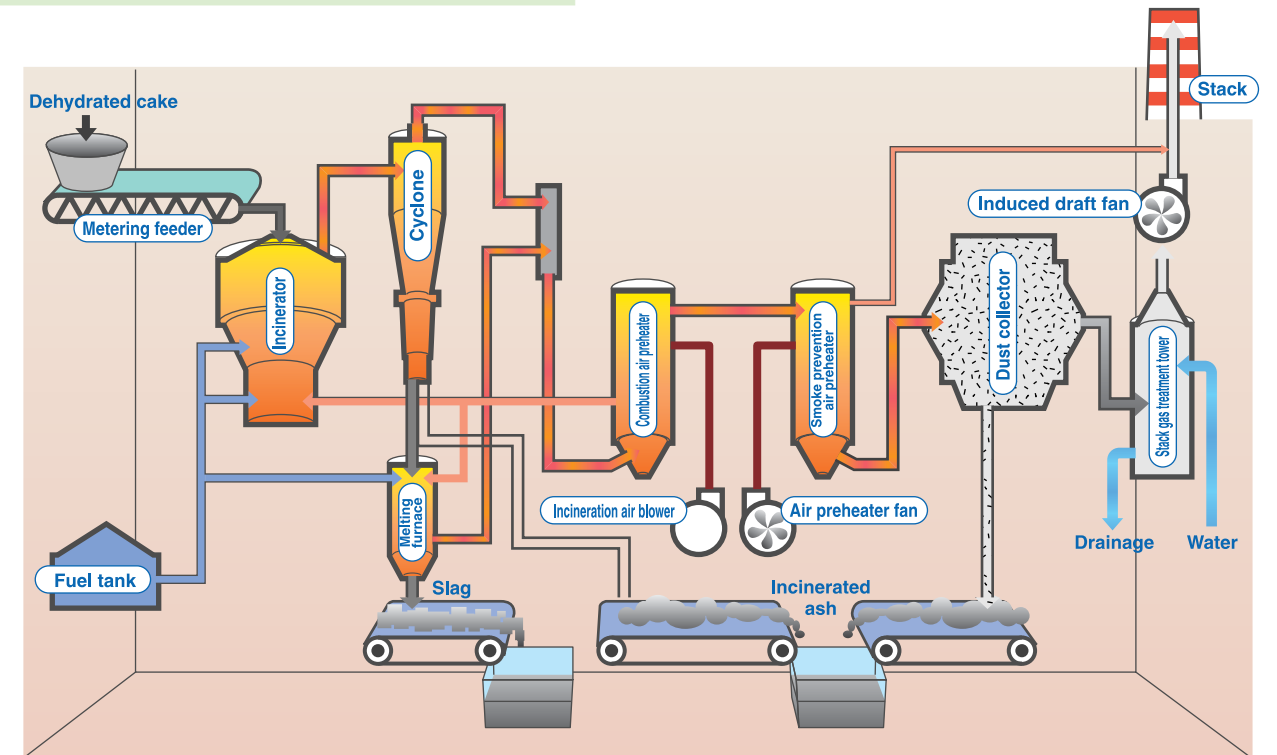

Example of incineration system configuration

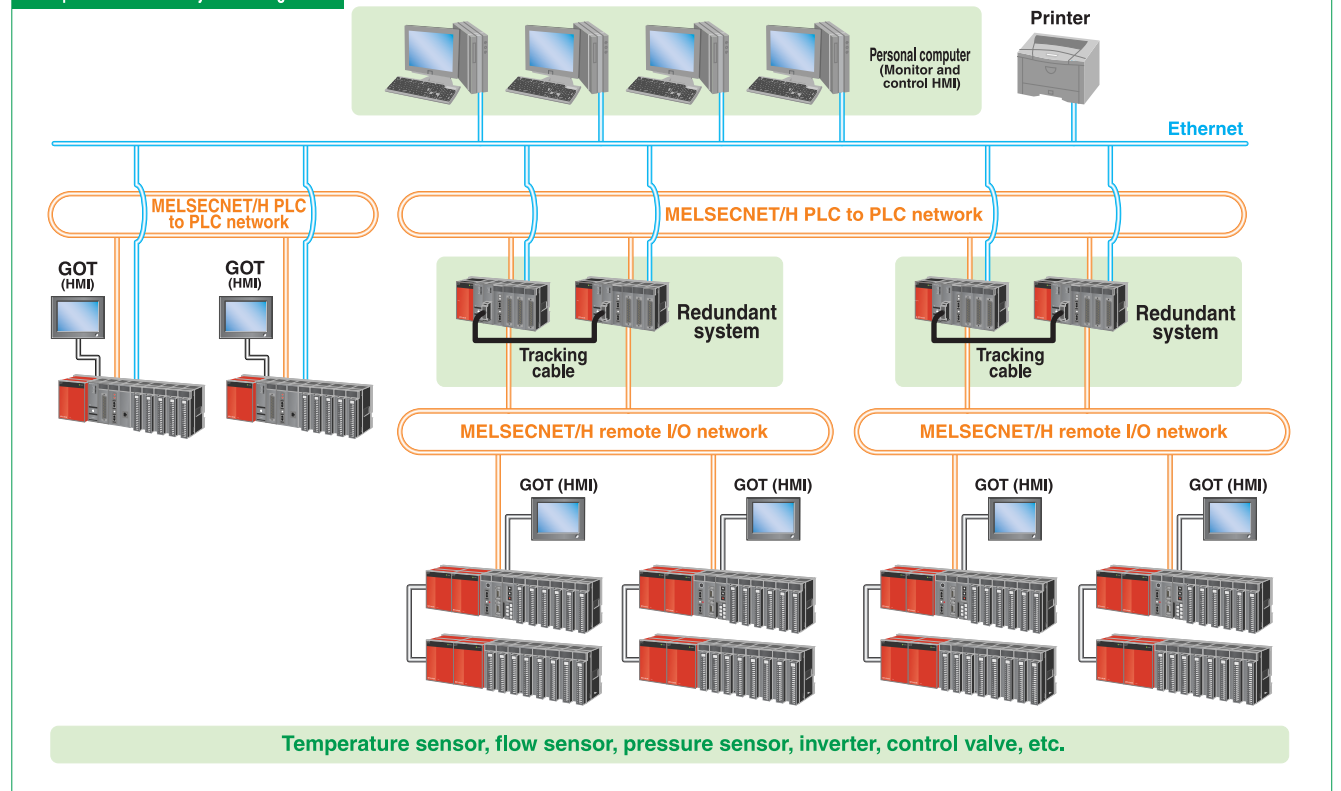



CPU module performance specifications

PLC CPU

Item	Basic Model			High Performance Model				
	Q00JCPU	Q00CPU	Q01CPU	Q02CPU	Q02HCPU	Q06HCPU	Q12HCPU	Q25HCPU
Control method	Sequence program control method							
I/O control mode	Refresh							
Programming language (Language dedicated to sequence control)	* Relay symbol language (ladder) * Logic symbolic language (list) * MELCAP3 (SFC), MELCAP-L * Structured text (ST)			* Relay symbol language (ladder) * Logic symbolic language (list) * MELCAP3 (SFC), MELCAP-L * Structured text (ST)				
Processing speed (Sequence instruction) (Note 1)	LD instruction	200ns	160ns	100ns	79ns	34ns		
	MOV instruction	700s	560ns	350ns	237ns	102ns		
	PC MIX value (Instruction/μs) (Note 2)	1.6	2.0	2.7	4.4	10.3		
	Floating-point addition	65.5μs	60.5μs	49.5μs	1815ns	782ns		
Total number of instructions (Note 3)	318	327		381				
Calculation (floating point calculation) instruction	Available			Available				
Character string processing instruction	Available (Note 6)			Available				
PID instruction	Available			Available				
Special function instruction (Trigonometric function, square root, exponential operation, etc.)	Available			Available				
Constant scan (Function to make scan time constant)	1 to 2000ms (set in 1ms units)			0.5 to 2000ms (set in 0.5ms units)				
Program capacity	8k step		14k step	28k step	60k step	124k step	252k step	
Number of I/O device points [X/Y]	2048 points			8192 points				
Number of I/O points [X/Y]	256 points	1024 points		4096 points				
Internal relay [M]	8192 points			8192 points				
Latch relay [L]	2048 points			8192 points				
Link relay [B]	2048 points			8192 points				
Timer [T]	512 points			2048 points				
Retentive timer [ST]	0			0				
Counter [C]	512 points			1024 points				
Data register [D]	11136 points			12288 points				
Link register [W]	2048 points			8192 points				
Annunciator [F]	1024 points			2048 points				
Edge relay [V]	1024 points			2048 points				
File register [R, ZR]	No	65536 points		32768 points (Note 5)	65536 points (Note 5)		131072 points (Note 5)	
Special link relay [SB]	1024 points			2048 points				
Special link register [SW]	1024 points			2048 points				
Step relay [S]	2048 points			8192 points				
Index register [Z]	10 points			16 points				
Pointer [P]	300 points			4096 points				
Interrupt pointer [I]	128 points			256 points				
Special relay [SM]	1024 points			2048 points				
Special register [SD]	1024 points			2048 points				
Function input [FX]	16 points			16 points				
Function output [FY]	16 points			16 points				
Function register [FD]	5 points			5 points				
Local device	None			Available				
Device initial values	Available			Available				

Note 1) The processing time will not be delayed if the devices are indexed.
 Note 2) The PC MIX value is the average number of instructions, such as basic instructions or data processing instructions, which can be executed in 1μs. The processing speed will rise as the value increases.
 Note 3) The intelligent function module's dedicated instructions are not included.
 Note 4) Indicates the number of points in the default state. This can be changed with the parameters.
 Note 5) Indicates the number of points when using the built-in memory (standard RAM).
 This can be expanded with the SRAM card and Flash card. (Writing from the program is not possible when using the Flash card.)
 Up to 1041408 points can be used when using the SRAM card.
 Note 6) The character strings can be used only with the character string data transfer instruction (\$MOV).

Process CPU

Item	Process CPU	
	Q12PHCPU	Q25PHCPU
Control method	Sequence program control method	
I/O control mode	Refresh	
Programming language	Language dedicated to sequence control	* Relay symbol language (ladder) * Logic symbolic language (list) * MELCAP3 (SFC), MELCAP-L * Structured text (ST)
	Language for process control	FBD for process control (Note 2)
Processing speed (Sequence instruction) (Note 1)	LD instruction	34ns
	MOV instruction	102ns
	PC MIX value (Instruction/μs) (Note 3)	10.3
	Floating-point addition	782ns
Total number of instructions (note 4)	415	
Calculation (floating point calculation) instruction	Available	
Character string processing instruction	Available	
Processing instruction	Available	
Special function instruction (Trigonometric function, square root, exponential operation, etc.)	Available	
Constant scan (Function to make scan time constant)	0.5 to 2000ms (set in 0.5ms units)	
Program capacity	124k step	252k step
Loop control specifications	Instructions for process control	52 types
	Number of control loops	No limitation (Note 4)
	Control cycle	10ms and higher control loop Variable per loop
	Main functions	2-degree of freedom PID control, cascade control, auto tuning function, feed forward control
Number of I/O device points [X/Y]	8192 points	
Number of I/O points [X/Y]	4096 points	
Internal relay [M]	8192 points	
Latch relay [L]	8192 points	
Link relay [B]	8192 points	
Timer [T]	2048 points	
Retentive timer [ST]	0 point	
Counter [C]	1024 points	
Data register [D]	12288 points	
Link register [W]	8192 points	
Annunciator [F]	2048 points	
Edge relay [V]	2048 points	
File register [R, ZR]	131072 points (Note 7)	
Special link relay [SB]	2048 points	
Special link register [SW]	2048 points	
Step relay [S]	8192 points	
Index register [Z]	16 points	
Pointer [P]	4096 points	
Interrupt pointer [I]	256 points	
Special relay [SM]	2048 points	
Special register [SD]	2048 points	
Function input [FX]	16 points	
Function output [FY]	16 points	
Function register [FD]	5 points	
Local device	Available	
Device default values	Available	

Note 1) The processing time will not be delayed if the devices are indexed.
 Note 2) Programming by FBD requires PX Developer.
 Note 3) The PC MIX value is the average number of instructions, such as basic instructions or data processing instructions, which can be executed in 1μs. The processing speed will rise as the value increases.
 Note 4) The intelligent function module's dedicated instructions are not included.
 Note 5) The number of control loops is limited by the combination of the device memory capacity (using 128 words/loop) and control cycle.
 Note 6) Indicates the number of points in the default state. This can be changed with the parameters.
 Note 7) Indicates the number of points when using the built-in memory (standard RAM).
 This can be expanded with the SRAM card and Flash card. (Writing from the program is not possible when using the Flash card.)
 Up to 1041408 points can be used when using the SRAM card.



Redundant CPU

Item	Redundant CPU	
	Q12PRHCPU	Q25PRHCPU
Control system	Cyclic program scan	
I/O control	Refresh mode	
Programming language	Sequence control dedicated language	<ul style="list-style-type: none"> Relay symbol language (ladder) Logic symbolic language (list) MELSP3 (SFC) Structured text (ST)
	Process control language	<ul style="list-style-type: none"> FBD for process control (Note 1)
Instruction types	Sequence, basic, application and process control instructions (Process control instruction types: Control/Operation instructions, I/O control instructions, compensation operation instructions, arithmetic operation instructions, comparison operation instructions, auto tuning instructions)	
Loop control specifications	Control cycle	10 ms /control loop (Can be set for each loop.)
	Number of control loops	No limit (Note 2)
RAS	Main functions	2-degree-of-freedom PID control, cascade control, automatic tuning function, feed forward control
	Online module replacement	The I/O, analog, temperature input, temperature control, and pulse input modules can be replaced (on a remote I/O station).
Functions compatible with redundant system	Output in case of error stop	Clear or output retention can be designated for each module.
	<ul style="list-style-type: none"> Redundant configuration of the entire system, Hot standby system for the control and standby systems online module change, including the CPU, the power supply, and the base unit selection of backup and separate modes available Large-capacity data tracking Large-capacity device data transfer (100k words) from the control system to the standby system Network system compatible with redundant system Switchover in case of MELSECNET/H or Ethernet module malfunction or network wire disconnection Engineering environment (GX Developer) Communication with programming tools The control or standby system can be designated by direct CPU connection or connection via a network Online program change function PLC write, online program change, online multi-block change Memory copy function Copying memory data from the control system to the standby system (Note 4) Redundant system setting The tracking device and network pairing can be set with parameters. 	
Communication port	USB, RS-232	
Modules that can be mounted on the main base unit	Q Series network module (Ethernet, MELSECNET/H, CC-Link only), input/output module can be mounted.	
Programming software	GX Developer	
	PX Developer	
Program capacity	Number of steps	124k steps
	Number of programs	124
Device memory capacity (Note 5)	Device memory: 29k words / File register (internal): 128k words (It can be extended up to 1017k words by adding a memory card (2 MB).)	
Number of I/O device points (Note 6)	8192 points	
Number of I/O points (Note 7)	4096 points	
Number of CPUs mounted	1 (multiple-CPU configuration is not available)	
Number of mountable modules	11 on the main base unit (7 when the power supply is redundant type)	
Number of extension base	0 (All non-redundant modules are mounted on the remote I/O station (the maximum number of modules that can be mounted on a remote station is 64).)	
Number of remote I/O points	8192 points (up to 2048 points per station)	

Note 1) PX Developer is required for programming by FBD.
 Note 2) The number of control loops is restricted by the combination of the device memory capacity (128k words/loop used) and the control cycle.
 Note 3) The maximum number of files that can be executed is 124. It is impossible to execute 125 or more files. Two SFC/MELSP3-Ls are available, one of which is a program execution control SFC.
 Note 4) The standard RAM, standard ROM and program memory can be copied from the control system to the standby system. The memory card cannot be copied.
 Note 5) Each number of device points in the data memory can be changed within 29k words, depending on the parameters.
 Note 6) Total number of the I/O points on the main base unit, which are directly controlled from the CPU module, and the I/O points controlled as remote I/O by the remote I/O network.
 Note 7) The number of I/O points on the main base unit, which are directly controlled from the CPU module.

Motion CPU

Item	Motion CPU			
	Q173HCPU (-T)	Q172HCPU (-T)	Q173CPUN (-T)	Q172CPUN (-T)
Number of control axes	SV13/SV22/SV43	32 axes	8 axes	32 axes (Max. of 16 axes x 2 per system)
	SV54	-	-	16 axes (Max. of 4 axes per machine)
Operation (Note 1) cycle (default)	SV13	0.44ms / 1 to 3 axes	0.44ms / 1 to 3 axes	0.88ms / 1 to 8 axes
		0.88ms / 4 to 10 axes	0.88ms / 4 to 8 axes	1.77ms / 9 to 16 axes
	SV22/SV43	1.77ms / 11 to 20 axes	1.77ms / 5 to 12 axes	3.55ms / 17 to 32 axes
		3.55ms / 21 to 32 axes	1.77ms / 6 to 14 axes	3.55ms / 13 to 24 axes
SV54	7.11ms / 29 to 32 axes	7.11ms / 25 to 32 axes	7.11ms / 9 to 16 axes	
	-	-	3.55ms / 1 to 8 axes	
Interpolation functions	SV13/SV22/SV43	Linear interpolation (Up to 4 axes), Circular interpolation (2 axes), Helical interpolation (3 axes)		
	SV54	3D linear interpolation (max. 4 axes), joint interpolation (max. 4 axes), 3D circular interpolation (max. 4 axes)		
Control modes	SV13/SV22	PTP (Point To Point) control, Speed control, Speed/position switching control, Fixed-pitch feed, Constant-speed control, Position follow-up control, Prescribed position stop speed control (Q173HCPU(-T) / Q172HCPU(-T)), Speed switching control, High-speed oscillation control, Synchronous control (SV22)		
	SV43	PTP (Point To Point), Constant-speed positioning, High-speed oscillation control		
Acceleration/deceleration control	SV54	PTP (Pose To Pose) control, CP (Configurable Path) control		
	SV54	Trapezoidal acceleration/deceleration, S-curve acceleration/deceleration, Post-interpolation acceleration/deceleration (SV54)		
Compensation function	Backlash compensation, Electronic gear, Phase compensation (SV22) Backlash compensation, Electronic gear			
Programming tool	SV13/SV22	Motion SFC, Dedicated instruction, Mechanical support language (SV22)		
	SV43	EIA language (G-code)		
	SV54	Robot language (MELFA-BASIC IV [Lite])		
Servo program (dedicated instruction) capacity	SV13/SV22	14k steps		
	SV43	248 Kbyte		
	SV54	Capacity of 1 program file: Max. 64 Kbyte Total capacity of all program files: Max. 339 Kbyte		

Item	Q173HCPU (-T)	Q172HCPU (-T)	Q173CPUN (-T)	Q172CPUN (-T)
Number of programs (SV54)	Max. 255			
Number of positioning points	SV13/SV22	3200 points (positioning data can be set indirectly)		
	SV43	Approx. 10600 points (indirect setting possible)		
	SV54	Internal variables: 1022 points / program External variables: 40 points (Indirect setting possible; position type (Pose), or joint type (Joint) format)		
Programming tool	IBM PC/AT			
Peripheral I/F	USB / SSCNET		USB / RS-232 / SSCNET	
Teaching function	Provided (when using Q17□HCPU-T / Q17□CPUN-T, SV13/SV54)			
Home position return function	Proximity dog type (2 types), Count type (3 types), Data set type (2 types), Dog cradle type, Stopper type (2 types), Limit switch combined type			
Jog operation function	Function present (with incremental feed function (SV54))			
Manual pulse generator operation function	Possible to connect 3 modules			
Synchronous encoder operation function	Possible to connect 12 modules (SV22 use)	Possible to connect 8 modules (SV22 use)	Possible to connect 12 modules (SV22 use)	Possible to connect 8 modules (SV22 use)
M-code function	M-code output function provided, M-code completion wait function provided			
Limit switch output function	Number of output points: 32 points Watch data: Motion control data/Word device			
ROM function	Yes		No	
Absolute position system	• Made compatible by setting battery to servo amplifier (Possible to select the absolute/incremental data method for each axis)			
Number of controlled machines (SV54)	Axis control machines	8 machines		
	Management machines	8 machines		
WAIT function (SV54)	With "Waiting for WAIT status" function, and "Device type/No. specific output during WAIT" function			
Number of Motion related modules	Q172LX: 4 modules	Q172LX: 1 module	Q172LX: 4 modules	Q172LX: 1 module
	Q172EX-S2: 6 modules (Note 2)	Q172EX-S2: 4 modules (Note 1)	Q172EX: 6 modules (Note 1)	Q172EX: 4 modules (Note 1)
	Q173PX: 4 modules (Note 3)	Q173PX: 3 modules (Note 2)	Q173PX: 4 modules (Note 2)	Q173PX: 3 modules (Note 2)
Program capacity	Code total (Motion SFC diagram + Operation control + Transition)	543kbyte		287kbyte
	Test total (Operation control + Transition)	484kbyte		224kbyte
Number of I/O (X/Y) points	8192 points			
Number of real I/O (PX/PY) points	256 points			
Number of devices	Internal relays (M)	Total (M+L): 8192 points		
	Latch relays (L)			
	Link relays (B)	8192 points		
	Annunciators (F)	2048 points		
	Special relay (M)	256 points		
	Data registers (D)	8192 points		
	Link registers (W)	8192 points		
	Special register (D)	256 points		
	Motion registers (#)	8192 points		
	Coasting timers (FT)	1 point (888µs)		

Note 1) SV43 is not used at Q172EX and Q172EX-S2.
 Note 2) The incremental synchronous encoder use (SV22). When connecting the manual pulse generator, you can use only one module.

GENERAL SPECIFICATIONS

General specifications indicate the environmental specifications in which this product can be installed and operated. Unless otherwise specified, the general specifications apply to all products of the Q series. Install and operate the Q series products in the environment indicated in the general specifications.

Item	Specifications			
Operating ambient temperature	0 to 55°C (Note 1)			
Storage ambient temperature	-25 to 75°C (Note 1) (Note 2)			
Operating ambient humidity	IEC (EN) 61131-2 Level RH-2 (5 to 95%RH: non-condensing) (Note 3)			
Storage ambient humidity	IEC (EN) 61131-2 Level RH-2 (5 to 95%RH: non-condensing) (Note 3)			
Vibration resistance	Conforming to IEC 61131-2			
	Under intermittent vibration Sweep count			
	Frequency	Acceleration	Amplitude	Sweep count
	10 to 57Hz	—	0.075mm	10 times each in X, Y, Z directions (for 80 min.)
	57 to 150Hz	9.8m/s²	—	
	Under continuous vibration			
Frequency	Acceleration	Amplitude		
10 to 57Hz	—	0.035mm		
57 to 150Hz	4.9m/s²	—		
Shock resistance	Conforming to IEC (EN) 61131-2 147 m/s², 3 times in each of 3 directions X, Y, Z			
Operating atmosphere	No corrosive gases			
Operating altitude	IEC (EN) 61131-2 2000m max. (Note 4)			
Installation location	Inside control box			
Overvoltage category	IEC (EN) 61131-2 (Category 2 or less) (Note 5)			
Pollution level	IEC (EN) 61131-2 Pollution level 2 or less. (Note 6)			

Note 1) The operating/storage ambient temperature satisfies the requirements beyond the requirements in IEC (EN) 61131-2.
 Note 2) When used with the AnS series modules, the Q series PLC should be stored at -20 to 75°C.
 Note 3) When used with the AnS series modules, the Q series PLC should be operated within 10 to 90%RH.
 Note 4) The PLC cannot be used under pressure higher than the atmospheric pressure of altitude 0m. Doing so can cause a failure.
 Note 5) This indicates the section of the power supply to which the equipment is assumed to be connected between the public electrical power distribution network and the machinery within premises. Category II applies to equipment for which electrical power is supplied from fixed facilities. The surge voltage withstand level for up to the rated voltage of 300V is 2500V.
 Note 6) This index indicates the degree to which conductive material is generated in the environment where the equipment is used. In pollution level 2, only non-conductive pollution occurs but temporary conductivity may be produced due to condensing.

INCREASED NEW POSSIBILITIES OF AUTOMATION APPLICATIONS



PC CPU Module Partner Products

Q Series is able to mount a fully featured PC directly on the Q main base unit alongside the I/O and other CPU types.

- Features**
- Complete PC functionality in the space of three standard Q Series I/O modules
 - Fully integrated into the Q Series system; the Q PC CPU is able to use all I/O, special function modules and networking options available with no special programming or hardware required
 - Supplied driver software provides numerous program functions to allow third party program environments (such as Visual Basic™ or Visual C++™) full access to all Q Series system components
 - Q PC may be used standalone with no other processor types to offer a completely PC based control system where required
 - May be combined with sequence, motion and process CPUs where required
 - Industrially hardened design offers the same durability as the rest of the Q Series hardware components
 - Comprehensive port selection allows multiple connection options to most third party devices (serial, parallel, USB, PCMCIA, Ethernet, monitor, keyboard, mouse, IDE, etc.)
 - Fanless construction avoids maintenance issues
 - Options for Microsoft Windows 2000, NT and NT Embedded
 - Options for rotating media or solid state silicon disks



Type	PPC-CPU686 (MS) -128	
MPU	Mobile Celeron Processor - LP 400MHz	
Memory	128MB	
Video memory	2MB	
IF	USB	2 channels (1 channel as extra connector)
	Serial	2 channels (D-SUB 9P) (1 channel as extra connector)
	Parallel	1 channel (extra connector)
	PS2 mouse/keyboard	Mini DIN 6P can be used simultaneously by conversion cable.
	LAN	100BASE-TX/10BASE-T
	Display	Analog RGB H-Dsub 15P
	FDD	26P half connector (for connection of Contec make FDD)
	PC card	PCMCIA, CardBus Type I, II x 2 or Type III x 1
Silicon disk module	Separate module (PCC-SDD (MS)-32/64/128/192/320/500/1000) 1 slot occupied	
Hard disk module	Separate module (PPC-HDD (MS)) 1 slot occupied	
OS	Windows® NT4.0, Windows® 2000, Windows® NT4.0 Embedded	

Absolute position detection unit Partner Product

The position detection unit "VS-Q62" provides absolute position data to programmable control unit and slots directly in the base of MELSEC-Q series.



- Features**
1. Release from the replacement and adjustment of switches with eliminating the needs for limit switch and DOG of position detection.
 2. Full resistance of heavy duty "ABSOCODER" to any harsh environments, such as vibrations, shocks, temperatures, oils, dusts and so on.

Model	VS-Q62
Axes	1
Detection	Absolute position (by means of "ABSOCODER")
Resolution	4096-409.6 Counts Per Turn & 32-320 Revolutions (with multi-turn ABSOCODER)
Data rate	0.2ms
Auxiliary	Current position, Preset, Positioning, Switching outputs

NSD provides various types of "ABSOCODER" (single-, multi- turn and linear type)

Contact: Suzuki-Haru (Sales Division)
SG Corporation (NSD Corporation Group)
Tel: +81-52-261-2352 Fax: +81-52-252-0522
NSD Corporation
URL: www.nsdcorp.co.jp E-mail: s-info@nsdcorp.co.jp

GP-IB Module Partner Products

The GP-IB module is mounted on the Q series PLC base to communicate with measuring devices through GP-IB line.



- Features**
1. The text length that can be communicated at one time for send and receive combined is as large as 63422 bytes.
 2. This module has a master/slave function. When the master function is selected, the module operates as a system controller and can send address, universal and other commands. When the slave function is selected, the module communicates data under the command of the system controller.

Type	EQGP-IB
Number of connectable units	Max. 15 units (including this module)
Connection cable length	Between module and device, between devices: Within 2m (Within a total of 20m in a single system)
Max. text length	63422 bytes for send and receive combined
Data transfer speed	Transfer speed of the slowest device among the connected devices
Access from program	Intelligent function module direct device (or FROM / TO instruction) and I/O instruction
Number of occupied	I/O points 16 points per slot

PLC peripheral devices Partner Products



EHGP10 handy graphic programmer

- **Peripheral device designed for field:**
The EHGP10 handy graphic programmer is a Peripheral device designed for field compatible with the MELSEC-QCPU as well as the QnA and A PLC CPUs. It also has high resistance to environment, and can be operated easily with the touch panel.
- **Programming unit:**
The EPU01 programming unit is compatible with the MELSEC-QCPU as well as the QnA and A PLC CPUs, and can edit programs in the CPU, test devices, and monitor devices. (For the QCPU, this programming unit is usable with the high-performance model only.)

Factory Automation Goods Partner Products

The Q series has a wide variation of useful goods to further expand PLC applications.

Product list

Class	Product	Type	Outline
CPU module-compatible communication module, intelligent module compatible	Connection cable	FA-CBLQC***R2	RS-232C cable for connection of personal computer and CPU (Mini-DIN 6P male)-(D-Sub 9P female) (3, 5, 15m)
		FA-CBL30USB	USB cable for connection of personal computer and CPU (3m)
		FA-CBL25P6P***	RS-232 cable for connection of personal computer, display or like and CPU (Mini-DIN 6P male)-(D-Sub 25P male) (3, 5, 14m)
		FA-CBL9S9P***	RS-232 cable for connection of personal computer and intelligent module (D-Sub 9P male)-(D-Sub 9P female) (3, 5, 15m)
	DC: Input, output module (connector type) compatible	Optical converter	FA-OPT232**
Conversion cable		FA-CBL25S***	Conversion cable for connection of optical converter (0.2m)
Conversion adaptor		FA-A25S***	Conversion adaptor for connection of optical converter
Fiber-optic cable		FA-FB***M*	Fiber-optic cable for connection of optical converter (within enclosure, indoors, portable, outdoors)
Screwless terminal block conversion module		FA-TE(W)32XY	32-point screwless terminal block module for DC
AC/DC: Input, output module (terminal block type) compatible	Quick connector type distributed module	FA-CB**XY*	Quick connector type 8- or 16-point distributed module for DC
	Connector/terminal block conversion module	FA-TB**XY*	Terminal block type 8- or 16-point distributed module or 32-point terminal block module for DC
	Connection cable	FA-CBL***FMV FA-(F)CBL***MMH	Cable for connection of input or output module and quick connector type distributed module or connector/terminal block conversion module Cable for connection of quick connector type distributed modules or terminal block type distributed modules
DC: Output module (connector type) compatible	Interface terminal unit	FA-TH16Y****	Relay, triac or transistor output terminal unit (16 points)
		Connection cable	FA-CBL***FM2V FA-CBL***MMH20
Positioning module compatible	Connection cable	FA-CBLQ75*****	Cable for connection of positioning module and servo amplifier (for QD75)
		FA-CBLQ70***	Cable for connection of positioning module and servo amplifier (for QD70)
Thermocouple input module compatible	Converter module	FA-TB20TD	Terminal block module for Q64TD Connection cable
	Connection cable	FA-CBLQ64TD**	Cable for connection of Q64TD terminal block module
Temperature control module	Converter module	FA-TB20TC	Terminal block module for Q64TCTT (BW)
	Connection cable	FA-CBLQ64TC**	Cable for connection of Q64TCTT (BW) terminal block module

A well-developed support system ensures smooth FA operations

Complying with international quality assurance standards.

All of Mitsubishi Electric's FA component products have acquired the international quality assurance "ISO9001" and environment management system standard "ISO14001" certification. Mitsubishi's products also comply with various safety standards, including UL Standards, and shipping standards.



Compatible Standards

Shipping Standards

- LR Lloyd's Register of Shipping approval
- DNV ... Norwegian Maritime approval
- RINA .. Italian Maritime approval
- NK ClassNK approval
- ABS ... American Bureau of Shipping approval
- BV Bureau Veritas approval
- GL Germanischer Lloyd approval

Safety Standards

- CE ... Council directive of the European Communities
- UL ... Underwriter Laboratory Listing

Details on each standard certification are disclosed on MELFANSweb. (<http://www.MitsubishiElectric.co.jp/melfansweb/english>)

Global FA Center

"Mitsubishi FA Centers" are located throughout North America, Europe and Asia to develop products complying with international standards and to provide attentive services.

Ⓞ NORTH AMERICAN FA CENTER

MITSUBISHI ELECTRIC AUTOMATION, INC.
500 Corporate Woods Parkway Vernon Hills, IL 60061 U.S.A.
Tel: 1-847-478-2100 Fax: 1-847-478-2396
The target area: North America, Mexico

Ⓞ EUROPEAN FA CENTER

MITSUBISHI ELECTRIC EUROPE B.V. GERMAN BRANCH
Gothaer Strasse 8 D-40880 Ratingen, Germany
Tel: 49-2102-486-0 Fax: 49-2102-486-7170
The target area: Europe

Ⓞ UK FA CENTER

MITSUBISHI ELECTRIC EUROPE B.V. UK BRANCH
(Customer Technical Center) Travellers Lane, Hatfield, Hertfordshire, AL10 8XB, UK
Tel: 44-1707-278843 Fax: 44-1707-278992
The target area: UK, Ireland

Ⓞ KOREAN FA CENTER

MITSUBISHI ELECTRIC AUTOMATION KOREA CO., LTD.
B1F, 2F, 1480-6, Deungchon-Dong, Kangseo-Ku, Seoul, 157-200, Korea
Tel: 82-2-3660-9607 Fax: 82-2-3664-0475
The target area: Korea

Ⓞ HONG KONG FA CENTER

MITSUBISHI ELECTRIC AUTOMATION (HONG KONG) LTD.
10/F., Manulife Tower, 169 Electric Road, North Point, Hong Kong
Tel: 852-2887-8870 Fax: 852-2887-7984
The target area: China

Ⓞ TIANJIN FA CENTER

MITSUBISHI ELECTRIC AUTOMATION (SHANGHAI) LTD. TIANJIN OFFICE
B-2-801-802, Youyi Building, 50 Youyi Road, Hexi District, Tianjin 300061, China
Tel: 86-22-28131015 Fax: 86-22-28131017
The target area: China

Ⓞ SHANGHAI FA CENTER

MITSUBISHI ELECTRIC AUTOMATION (SHANGHAI) LTD.
1-3/F., Block5, 103 Cao Bao Road, Shanghai 200233, China
Tel: 86-21-6484-9360 Fax: 86-21-6484-9361
The target area: China

Ⓞ BEIJING FA CENTER

MITSUBISHI ELECTRIC AUTOMATION (SHANGHAI) LTD., BEIJING OFFICE
Unit 917-918, 9/F Office Tower 1, Hendsen Center, 18 Jianquomennei Dajie, Dongcheng District, Beijing 100005 China
Tel: 86-10-6518-8830 Fax: 86-10-6518-8030
The target area: China

Ⓞ TAIWAN FA CENTER

SETSUYO ENTERPRISE CO., LTD.
6F No.105 Wu-Kung 3rd. RD, Wu-Ku Hsiang Taipei Hsien, Taiwan
Tel: 886-2-2299-2499 Fax: 886-2-2299-2509
The target area: Taiwan

Ⓞ ASEAN FA CENTER

MITSUBISHI ELECTRIC ASIA PTE, LTD.
307 Alexandra Road #05-01/02 Mitsubishi Electric Building Singapore, 159943
Tel: 65-6470-2480 Fax: 65-6476-7439
The target area: Southeast Asia, India

Online information for reference and learning...The MELFANSweb offers speedy answers to questions about Mitsubishi FA devices.

MELFANSweb – your source for FA information

The "MELFANSweb" offers a wealth of information concerning Mitsubishi FA devices. Registering over 100,000 hits a day, the site is clearly popular with our customers. The MELFANSweb content includes information about products, an FA terminology glossary, and information about seminars and FA devices, and it represents a powerful resource for users of Mitsubishi FA



MELFANSweb web site URL:

<http://www.MitsubishiElectric.co.jp/english/>

List of Related Catalogs

01. MELSEC Q Series Data Book L (NA) 08029E
02. MELSEC Process Control Catalog L (NA) 08030E-A
03. Motion Controller Catalog L (NA) 03014-B
04. CC-Link, CC-Link/CT Catalog L (NA) 08038E-A
05. CC-Link and CC-Link/LT Compatible product databook L (NA) 08039E-A
06. MELSOFT Catalog L (NA) 08008-C
07. GOT-1000 series Catalog L (NA) 08054E
08. MELSERVO-J2-Super Catalog L (NA) 03007
09. MELSERVO-J3-Super Catalog L (NA) 03017-B
10. Inverter Family Catalog L (NA) 06036





WARRANTY

Please confirm the following product warranty details before starting use.

Gratis Warranty Term and Gratis Warranty Range

If any faults or defects (hereinafter "Failure") found to be the responsibility of Mitsubishi occurs during use of the product within the gratis warranty term, the product shall be repaired at no cost via the dealer or Mitsubishi Service Company. Note that if repairs are required at a site overseas, on a detached island or remote place, expenses to dispatch an engineer shall be charged for. Mitsubishi shall not be held responsible for readjustment and trial operations at the site resulting from replacement of faulty modules.

Gratis Warranty Term

The gratis warranty term of the product shall be for one year after the date of purchase or delivery to a designated place. Note that after manufacture and shipment from Mitsubishi, the maximum distribution period shall be six (6) months, and the longest gratis warranty term after manufacturing shall be eighteen (18) months. The gratis warranty term of repair parts shall not exceed the gratis warranty term before repairs.

Gratis Warranty Range

- (1) The range shall be limited to normal use within the usage state, usage methods and usage environment, etc., which follow the conditions and precautions, etc., given in the instruction manual, user's manual and caution labels on the product.
- (2) Even within the gratis warranty term, repairs shall be charged for in the following cases.
 1. Failure occurring from inappropriate storage or handling, carelessness or negligence by the user. Failure caused by the user's hardware or software design.
 2. Failure caused by unapproved modifications, etc., to the product by the user.
 3. When the Mitsubishi product is assembled into a user's device, Failure that could have been avoided if functions or structures, judged as necessary in the legal safety measures the user's device is subject to or as necessary by industry standards, had been provided.
 4. Failure that could have been avoided if consumable parts (battery, backlight, fuse, etc.) designated in the instruction manual had been correctly serviced or replaced.
 5. Failure caused by external irresistible forces such as fires or abnormal voltages, and Failure caused by force majeure such as earthquakes, lightning, wind and water damage.
 6. Failure caused by reasons unpredictable by scientific technology standards at time of shipment from Mitsubishi.
 7. Any other failure found not to be the responsibility of Mitsubishi or the user.

Onerous repair term after discontinuation of production

- (1) Mitsubishi shall accept onerous product repairs for seven (7) years after production of the product is discontinued. Discontinuation of production shall be notified with Mitsubishi Technical Bulletins, etc.
- (2) Product supply (including repair parts) is not possible after production is discontinued.

Overseas service

Overseas, repairs shall be accepted by Mitsubishi's local overseas FA Center. Note that the repair conditions at each FA Center may differ.

Exclusion of chance loss and secondary loss from warranty liability

Regardless of the gratis warranty term, Mitsubishi shall not be liable for compensation to damages caused by any cause found not to be the responsibility of Mitsubishi, chance losses, lost profits incurred to the user by Failures of Mitsubishi products, damages and secondary damages caused from special reasons regardless of Mitsubishi's expectations, compensation for accidents, and compensation for damages to products other than Mitsubishi products and other duties. In addition, Mitsubishi shall not be liable for compensation resulting from replacement work carried out by user, readjustment of machinery and facilities at site, trial operation at startup or any other duties.

Changes in product specifications

The specifications given in the catalogs, manuals or technical documents are subject to change without prior notice.

Product application

- (1) In using the Mitsubishi MELSEC programmable logic controller, the usage conditions shall be that the application will not lead to a major accident even if any problem or fault should occur in the programmable logic controller device, and that backup and fail-safe functions are systematically provided outside of the device for any problem or fault.
- (2) The Mitsubishi general-purpose programmable logic controller has been designed and manufactured for applications in general industries, etc. Thus, applications in which the public could be affected such as in nuclear power plants and other power plants operated by respective power companies, and applications in which a special quality assurance system is required, such as for Railway companies or National Defense purposes shall be excluded from the programmable logic controller applications. When considering use in aircraft, medical applications, railways, incineration and fuel devices, manned transport devices, equipment for recreation and amusement, and safety devices, in which human life or assets could be greatly affected and for which a particularly high reliability is required in terms of safety and control system, please consult with Mitsubishi and discuss the required specifications. Note that even with these applications, if the user approves that the application is to be limited and a special quality is not required, application shall be possible upon due process of documents.

* Always refer to the "Q series data book" for information on usable modules and restrictions, etc., before starting use.
* Refer to MELFANSweb or contact your nearest sales office for the latest information on the MELSOFT versions and compatible OS.

- Usable with basic model
- Usable with high-performance model
- Usable with process CPU
- Usable with redundant CPU
- Usable with MELSECNET/H remote I/O

CPU, base, power supply

Product	Type	Outline
CPU	Basic Model	Q00JCPU No. of input/output points: 256 points No. of input/output device points: 2048 points Program capacity: 8k steps Basic instruction processing speed (LD instruction): 0.20μs Program memory capacity: 58kbyte 5 slots 100 to 240VAC input/5VDC 3A output power supply
		Q00CPU No. of input/output points: 1024 points No. of input/output device points: 2048 points Program capacity: 8k steps Basic instruction processing speed (LD instruction): 0.16μs Program memory capacity: 94kbyte
		Q01CPU No. of input/output points: 1024 points No. of input/output device points: 2048 points Program capacity: 14k steps Basic instruction processing speed (LD instruction): 0.10μs Program memory capacity: 94kbyte
	High Performance Model	Q02CPU No. of input/output points: 4096 points No. of input/output device points: 8192 points Program capacity: 28k steps Basic instruction processing speed (LD instruction): 0.079μs Program memory capacity: 112kbyte
		Q02HCPU No. of input/output points: 4096 points No. of input/output device points: 8192 points Program capacity: 28k steps Basic instruction processing speed (LD instruction): 0.034μs Program memory capacity: 112kbyte
		Q06HCPU No. of input/output points: 4096 points No. of input/output device points: 8192 points Program capacity: 60k steps Basic instruction processing speed (LD instruction): 0.034μs Program memory capacity: 240kbyte
		Q12HCPU No. of input/output points: 4096 points No. of input/output device points: 8192 points Program capacity: 124k steps Basic instruction processing speed (LD instruction): 0.034μs Program memory capacity: 496kbyte
	Process CPU	Q12PHCPU No. of input/output points: 4096 points No. of input/output device points: 8192 points Program capacity: 124k steps Basic instruction processing speed (LD instruction): 0.034μs Program memory capacity: 496kbyte
		Q25PHCPU No. of input/output points: 4096 points No. of input/output device points: 8192 points Program capacity: 252k steps Basic instruction processing speed (LD instruction): 0.034μs Program memory capacity: 1008kbyte
	Redundant CPU	Q12PRHCPU No. of input/output points: 4096 points No. of input/output device points: 8192 points Program capacity: 124k steps Basic instruction processing speed (LD instruction): 0.034μs Program memory capacity: 496kbyte
		Q25PRHCPU No. of input/output points: 4096 points No. of input/output device points: 8192 points Program capacity: 252k steps Basic instruction processing speed (LD instruction): 0.034μs Program memory capacity: 1008kbyte
	Motion CPU	Q172CPUN For 8-axis control
		Q172CPUN-T For 8-axis control, teaching module supported
		Q172HCPU For 8-axis control, SSCNET III connection
		Q172HCPU-T For 8-axis control, SSCNET III connection, teaching module supported
		Q173CPUN For 32-axis control
		Q173CPUN-T For 32-axis control, teaching module supported
		Q173HCPU For 32-axis control, SSCNET III connection
	Q173HCPU-T For 32-axis control, SSCNET III connection, teaching module supported	
	Battery	Q6BAT Replacement battery
Q7BAT Large capacity battery		
Q7BAT-SET Large capacity battery with holder		
Q8BAT Replacement large-capacity battery module Without cable		
Q8BAT-SET Large capacity battery module With cable		
Memory card	Q2MEM-1MBS SRAM memory card Capacity: 1Mbyte	
	Q2MEM-2MBS SRAM memory card Capacity: 2Mbyte	
	Q2MEM-2MBF Linear Flash memory card Capacity: 2Mbyte	
	Q2MEM-4MBF Linear Flash memory card Capacity: 4Mbyte	
	Q2MEM-8MBA ATA card Capacity: 8Mbyte	
	Q2MEM-16MBA ATA card Capacity: 16Mbyte	
	Q2MEM-32MBA ATA card Capacity: 32Mbyte	
Memory card adaptor Q2MEM-ADP Adaptor for Q2MEM memory card's standard PCMCIA slot		
SRAM card battery Q2MEM-BAT Replacement battery for Q2MEM-1MBS/ Q2MEM-2MBS		
Connection cable QC30R2 RS-232 cable for connection of personal computer and CPU, 3m (mini-DIN 6P)-(Dsub 9P)		
Tracking cable QC10TR 1m cable for tracking		
QC30TR 3m cable for tracking		
Cable disconnection prevention holder Q6HLD-R2 Holder for prevention of RS-232 cable disconnection		
Base	Main base	Q33B 3 slots power supply module, mountable for Q series modules
		Q35B 5 slots power supply module, mountable for Q series modules
		Q38B 8 slots power supply module, mountable for Q series modules
		Q312B 12 slots power supply module, mountable for Q series modules
	Slim type main base	Q32SB 2 slots slime type power supply module, mountable for Q series modules
		Q33SB 3 slots slime type power supply module, mountable for Q series modules
Q35SB 5 slots slime type power supply module, mountable for Q series modules		



CPU, base, power supply

Product	Type	Outline	
Base	Extension base	Q63B 	3 slots power supply module, mountable for Q series modules
		Q65B 	5 slots power supply module, mountable for Q series modules
	Main base for power supply redundant system	Q38RB	8 slots two power supply modules for power supply redundant system, mountable for Q series modules
	Extension base	Q68B 	8 slots power supply module, mountable for Q series modules
		Q612B 	12 slots power supply module, mountable for Q series modules
		Q52B 	2 slots power supply module, mountable for Q series modules
		Q55B 	5 slots power supply module, mountable for Q series modules
		QA1S65B (* 1) 	5 slots power supply module, mountable for AnS series modules
		QA1S68B (* 1) 	8 slots power supply module, mountable for AnS series modules
		QA65B (* 1) 	5 slots power supply module, mountable for A series modules
	Extension base power supply redundant system	Q68RB 	8 slots two power supply modules for power supply redundant system, mountable for Q series modules
	Extension cable	QC05B	0.45m cable for Q52B, Q55B, Q63B, Q65B, Q68B, Q612B, Q38RB, Q68RB
		QC06B	0.6m cable for Q52B, Q55B, Q63B, Q65B, Q68B, Q612B, Q38RB, Q68RB
		QC12B	1.2m cable for Q52B, Q55B, Q63B, Q65B, Q68B, Q612B, Q38RB, Q68RB
		QC30B	3m cable for Q52B, Q55B, Q63B, Q65B, Q68B, Q612B, Q38RB, Q68RB
		QC50B	5m cable for Q52B, Q55B, Q63B, Q65B, Q68B, Q612B, Q38RB, Q68RB
		QC100B	10m cable for Q52B, Q55B, Q63B, Q65B, Q68B, Q612B, Q38RB, Q68RB
	Adaptor	Q6DIN1	DIN rail mounting adaptor for Q38B, Q312B, Q68B, Q612B, Q38RB, Q68RB
		Q6DIN2	DIN rail mounting adaptor for Q35B, Q65B, Q00JCPU
		Q6DIN3	DIN rail mounting adaptor for Q32SB, Q33SB, Q35SB, Q33B, Q52B, Q55B, Q63B
Blank cover	QG60	Blank cover for I/O slot	
Power supply	Q61P-A1	Input voltage range: 100-120VAC Output voltage: 5VDC Output current: 6A	
	Q61P-A2	Input voltage range: 200-240VAC Output voltage: 5VDC Output current: 6A	
	Q62P	Input voltage range: 100 to 240VAC Output voltage: 5/24VDC Output current: 3/0.6A	
	Q63P	Input voltage range: 24VDC Output voltage: 5VDC Output current: 6A	
	Q64P	Input voltage range: 100 to 120VAC/200 to 240VAC Output voltage: 5VDC Output current: 8.5A	
Slim type power supply	Q61SP	Input voltage range: 100 to 240VAC Output voltage: 5VDC Output current: 2A Slim type power supply	
Power supply for power supply redundant system	Q63RP	Input voltage range: 24VDC Output voltage: 5VDC Output current: 8.5A	
	Q64RP	Input voltage range: 100 to 120VAC/200 to 240VAC Output voltage: 5VDC Output current: 8.5A	

Input/output module

Product	Type	Outline	
Input	AC	QX10	16 points 100 to 120VAC 8mA (100VAC, 60Hz)/7mA (100VAC, 50Hz) response time: 20ms 16 points/common 18-point terminal block
		QX28	8 points 100 to 240VAC 17mA (200VAC, 60Hz)/14mA (200VAC, 50Hz)/8mA (100VAC, 60Hz) / 7mA (100VAC, 50Hz) response time: 20ms 8 points/common 18-point terminal block
	DC (Positive common) (* 2)	QX40	16 points 24VDC 4mA response time: 1/5/10/20/70ms 16 points/common Positive common 18-point terminal block
		QX40-S1	16 points 24VDC 6mA response time: 0.1/0.2/0.4/0.6/1ms 16 points/common Positive common 18-point terminal block
		QX41 (* 3)	32 points 24VDC 4mA response time: 1/5/10/20/70ms 32 points/common Positive common 40-pin connector
		QX41-S1 (* 3)	32 points 24VDC 4mA response time: 0.1/0.2/0.4/0.6/1ms 32 points/common Positive common 40-pin connector
		QX42 (* 3)	64 points 24VDC 4mA response time: 1/5/10/20/70ms 32 points/common Positive common 40-pin connector
		QX42-S1 (* 3)	64 points 24VDC 4mA response time: 0.1/0.2/0.4/0.6/1ms 32 points/common Positive common 40-pin connector
	DC sensor (* 2)	QX70	16 points 5/12VDC 1.2mA (5VDC)/3.3mA (12VDC) response time: 1/5/10/20/70ms 16 points/common positive common/negative common combination use 18-point terminal block
		QX71 (* 3)	32 points 5/12VDC 1.2mA (5VDC)/3.3mA (12VDC) response time: 1/5/10/20/70ms 32 points/common positive common/negative common combination use 40-pin connector
		QX72 (* 3)	64 points 5/12VDC 1.2mA (5VDC)/3.3mA (12VDC) response time: 1/5/10/20/70ms 32 points/common positive common/negative common combination use 40-pin connector

Input/output module

Product	Type	Outline		
Input/output	DC (Negative common) (* 2)	QX80	16 points 24VDC 4mA response time: 1/5/10/20/70ms 16 points/common negative common 18-point terminal block	
		QX81 (* 4)	32 points 24VDC 4mA response time: 1/5/10/20/70ms 32 points/common negative common 37-pin D-sub connector	
		QX82 (* 3)	64 points 24VDC 4mA response time: 1/5/10/20/70ms 32 points/common negative common 40-pin connector	
		QX82-S1 (* 3)	64 points 24VDC 4mA response time: 0.1/0.2/0.4/0.6/1ms 32 points/common negative common 40-pin connector	
	Relay	QY10	16 points 24VDC/240VAC 2A/point 8A/common response time: 12ms 16 points/common 18-point terminal block	
		QY18A	8 points 24VDC/240VAC 2A/point response time: 12ms 18-point terminal block all points independent Relay	
	Output	Triac	QY22	16 points 100 to 240VAC 0.6A/points 4.8A/common Minimum load voltage Current: 24VAC 100mA/100/240VAC 25mA Leakage at OFF: 1.5mA (120VAC) / 3mA (240VAC) response time: 1ms + 0.5Hz 16 points/common 18-point terminal block with surge suppressor
			QY40P	16 points 12 to 24VDC 0.1A/points 1.6A/common Leakage at OFF: 0.1mA response time: 1ms 16 points/common sink type 18-point terminal block with thermal protection, short-circuit protection and surge suppressor
		Transistor (Sink)	QY41P (* 3)	32 points 12 to 24VDC 0.1A/points 2A/common Leakage at OFF: 0.1mA response time: 1ms 32 points/common sink type 40-pin connector with thermal protection, short-circuit protection and surge suppressor
			QY42P (* 3)	64 points 12 to 24VDC 0.1A/points 2A/common Leakage at OFF: 0.1mA response time: 1ms 32 points/common sink type 40-pin connector with thermal protection, short-circuit protection and surge suppressor
			QY50	16 points 12 to 24VDC 0.5A/points 4A/common Leakage at OFF: 0.1mA response time: 1ms 16 points/common sink type 18-point terminal block with thermal protection, surge suppressor and fuse
		Transistor (Independent)	QY68A	8 points 5 to 24VDC 2A/points 8A/module Leakage at OFF: 0.1mA response time: 10ms sink/source combination type 18-point terminal block with surge suppressor all points independent
			TTL CMOS	QY70
QY71 (* 3)		32 points 5 to 12VDC 16mA/points 512mA/common response time: 0.5ms 32 points/common sink type 40-pin connector with fuse		
Transistor (Source)	QY80	16 points 12 to 24VDC 0.5A/points 4A/common Leakage at OFF: 0.1mA response time: 1ms 16 points/common source type 18-point terminal block with surge suppressor and fuse		
	QY81P (* 4)	32 points 12 to 24VDC 0.1A/points 2A/common Leakage at OFF: 0.1mA response time: 1ms 32 points/common source type 37-pin D-sub connector with thermal protection, short-circuit protection and surge suppressor		
Input/output	DC input/transistor output	QH42P (* 3)	Input 32 points 24VDC 4mA response time: 1/5/10/20/70ms Positive common output 32 points 12 to 24VDC 0.1A/points 2A/common Leakage at OFF: 0.1mA response time: 1ms sink type 40-pin connector with thermal protection, short-circuit protection and surge suppressor	
		QX48Y57	Input 8 points 24VDC 4mA response time: 1/5/10/20/70ms Positive common output 7 points 12 to 24VDC 0.5A/points 2A/common Leakage at OFF: 0.1mA response time: 1ms 7 points/common sink type 18-point terminal block with surge suppressor and fuse	
Interrupt module	QI60	16 points 24VDC 4mA response time: 0.1/0.2/0.4/0.6/1ms 16 points/common 18-point terminal block		
Connector	A6CON1	Soldering 32-point connector (40-pin connector)		
	A6CON2	Solderless terminal connection 32-point connector (40-pin connector)		
	A6CON3	Flat cable pressure-displacement 32-point connector (40-pin connector)		
	A6CON4	Soldering 32-point connector (40-pin connector, bidirectional cable mountable)		
	A6CON1E	Soldering 32-point connector (37-pin D-sub connector)		
	A6CON2E	Solderless terminal connection 32-point connector (37-pin D-sub connector)		
	A6CON3E	Flat cable pressure-displacement 32-point connector (37-pin D-sub connector)		
Spring clamp terminal block	Q6TE-18S	For 16-point I/O, 0.3 to 1.5mm ² (AWG22 to 16)		
Terminal block adaptor	Q6TA32	For 32-point I/O, 0.5mm ² (AWG20)		
	Q6TA32-TOL	Tool exclusively used for Q6TA32		
	A6TBX36-E	For negative common input module (standard type)		
Connector/terminal block conversion module	A6TBX54-E	For negative common input module (2-wire type)		
	A6TBX70	For positive common input module (3-wire type)		
	A6TBX70-E	For negative common input module (3-wire type)		
	A6TBY36-E	For source type output module (standard type)		
	A6TBY54-E	For source type output module (2-wire type)		
	A6TBYX36	For positive common input module, sink type output module (standard type)		
	A6TBYX54	For positive common input module, sink type output module (2-wire type)		
Connector/terminal block conversion module	Cable	AC05TB	For A6TBXY36/A6TBXY54/A6TBX70 (positive common, for sink type) 0.5m	
		AC10TB	For A6TBXY36/A6TBXY54/A6TBX70 (positive common, for sink type) 1m	
		AC20TB	For A6TBXY36/A6TBXY54/A6TBX70 (positive common, for sink type) 2m	
		AC30TB	For A6TBXY36/A6TBXY54/A6TBX70 (positive common, for sink type) 3m	
		AC50TB	For A6TBXY36/A6TBXY54/A6TBX70 (positive common, for sink type) 5m	
		AC80TB	For A6TBXY36/A6TBXY54/A6TBX70 (positive common, for sink type) 8m *Common power supply 0.5A or less	
		AC100TB	For A6TBXY36/A6TBXY54/A6TBX70 (positive common, for sink type) 10m *Common power supply 0.5A or less	
		AC05TB-E	For A6TBX-E/A6TBY36-E/A6TBX54-E/A6TBY54-E/A6TBX70-E (negative common, for source type) 0.5m	
		AC10TB-E	For A6TBX-E/A6TBY36-E/A6TBX54-E/A6TBY54-E/A6TBX70-E (negative common, for source type) 1m	



Input/output module

Product	Type	Outline
Connector/ terminal block conversion module	Cable	AC20TB-E For A6TBX-E/A6TBY36-E/A6TBX54-E/A6TBY54-E/A6TBX70-E (negative common, for source type) 2m
		AC30TB-E For A6TBX-E/A6TBY36-E/A6TBX54-E/A6TBY54-E/A6TBX70-E (negative common, for source type) 3m
		AC50TB-E For A6TBX-E/A6TBY36-E/A6TBX54-E/A6TBY54-E/A6TBX70-E (negative common, for source type) 5m
Relay terminal module	A6TE2-16SRN	For 40-pin connector 24VDC transistor output module (sink type)
Relay terminal module Cable	Cable	AC06TE 0.6m for A6TE2-16SRN
		AC10TE 1m for A6TE2-16SRN
		AC30TE 3m for A6TE2-16SRN
		AC50TE 5m for A6TE2-16SRN
		AC100TE 10m for A6TE2-16SRN

Analog input/output module

Product	Type	Outline	
Analog input	Voltage input	Q68ADV 8 channels Input: -10 to 10VDC Output (resolution): 0 to 4000, -4000 to 4000, 0 to 12000, -12000 to 12000, 0 to 16000, -16000 to 16000 Conversion speed: 80µs/channel 18-point terminal block	
		Q62AD-DGH 2 channels Input: 4 to 20mADC Output (resolution): 0 to 32000, 0 to 64000 Conversion speed: 10ms/2channel 18-point terminal block channel isolated, power supply to 2-wire transmitter	
	Current input	Q68ADI 8 channels Input: 0 to 20mADC Output (resolution): 0 to 4000, -4000 to 4000, 0 to 12000, -12000 to 12000, 0 to 16000, -16000 to 16000 Conversion speed: 80µs/channel 18-point terminal block	
		Q64AD 4 channels Input: -10 to 10VDC, 0 to 20mADC Output (resolution): 0 to 4000, -4000 to 4000, 0 to 12000, -12000 to 12000, 0 to 16000, -16000 to 16000 Conversion speed: 80µs/channel 18-point terminal block	
	Voltage/ current input	Q64AD-GH 4 channels Input: -10 to 10VDC, 0 to 20mADC Output (resolution): 0 to 32000, -32000 to 32000, 0 to 64000, -64000 to 64000 Conversion speed: 10ms/4channel 18-point terminal block channel isolated	
		Q68DAVN 8 channels Input (resolution): 0 to 4000, -4000 to 4000, 0 to 12000, -12000 to 12000, -16000 to 16000 Output: -10 to 10VDC Conversion speed: 80µs/channel 18-point terminal block Isolated transformer between power supply and output.	
Analog output	Voltage output	Q68DAV 8 channels Input (resolution): 0 to 4000, -4000 to 4000, 0 to 12000, -12000 to 12000, -16000 to 16000 Output: -10 to 10VDC Conversion speed: 80µs/channel 18-point terminal block	
		Q68DAIN 8 channels Input (resolution): 0 to 4000, -4000 to 4000, 0 to 12000, -12000 to 12000 Output: 0 to 20mADC Conversion speed: 80µs/channel 18-point terminal block Isolated transformer between power supply and output.	
	Current output	Q68DAI 8 channels Input (resolution): 0 to 4000, -4000 to 4000, 0 to 12000, -12000 to 12000 Output: 0 to 20mADC Conversion speed: 80µs/channel 18-point terminal block	
		Q62DAN 2 channels Input (resolution): 0 to 4000, -4000 to 4000, 0 to 12000, -12000 to 12000, -16000 to 16000 Output: -10 to 10VDC, 0 to 20mADC Conversion speed: 80µs/channel 18-point terminal block Isolated transformer between power supply and output.	
	Voltage/ current output	Q62DA 2 channels Input (resolution): 0 to 4000, -4000 to 4000, 0 to 12000, -12000 to 12000, -16000 to 16000 Output: -10 to 10VDC, 0 to 20mADC Conversion speed: 80µs/channel 18-point terminal block	
		Q62DA-FG 2 channels Input (resolution): 0 to 12000, -12000 to 12000, -16000 to 16000 Output: -12 to 12VDC, 0 to 22mADC Conversion speed: 10ms/2channel 18-point terminal block channel isolated	
		Q64DAN 4 channels Input (resolution): 0 to 4000, -4000 to 4000, 0 to 12000, -12000 to 12000, -16000 to 16000 Output: -10 to 10VDC, 0 to 20mADC Conversion speed: 80µs/channel 18-point terminal block Isolated transformer between power supply and output.	
		Q64DA 4 channels Input (resolution): 0 to 4000, -4000 to 4000, 0 to 12000, -12000 to 12000, -16000 to 16000 Output: -10 to 10VDC, 0 to 20mADC Conversion speed: 80µs/channel 18-point terminal block	
		Q64RD 4 channels Platinum temperature-measuring resistor (Pt100 (JIS C 1604-1997, IEC 751 1983), JPt100 (JIS C1604-1981)) conversion speed: 40ms/channel 18-point terminal block	
		Q64RD-G 4 channels Platinum temperature-measuring resistor (Pt100 (JIS C1604-1997, IEC 751 1983), JPt100 (JIS C1604-1981), Ni100W (DIN43760 1987)) Conversion speed: 40ms/channel 18-point terminal block channel isolated	
	Temperature input	Thermocouple	Q64TD 4 channels thermocouple (JIS C1602-1995) conversion speed: 40ms/channel 18-point terminal block
			Q64TDV-GH 4 channels thermocouple (JIS C1602-1995) micro voltage (-100mV to 100mV) conversion speed: (sampling cycle x 3)/channel 18-point terminal block
Temperature control	Platinum temperature- measuring resistor	Q64TCRT 4 channels Platinum temperature-measuring resistor (Pt100, JPt100) No heater wire break detection sampling cycle: 0.5s/4 channels 18-point terminal block	
		Q64TCRTBW 4 channels Platinum temperature-measuring resistor (Pt100, JPt100) heater wire break detection sampling cycle: 0.5s/4 channel 18-point terminal block x 2	
	Thermocouple	Q64TCTT 4 channels thermocouple (K, J, T, B, S, E, R, N, U, L, PLII, W5Re/W26Re) No heater wire break detection sampling cycle: 0.5s/4 channel 18-point terminal block	
		Q64TCTTBW 4 channels thermocouple (K, J, T, B, S, E, R, N, U, L, PLII, W5Re/W26Re) Heater wire break detection Sampling cycle: 0.5s/4 channel 18-point terminal block x 2	
	Loop control module	Q62HLC Loop control module 2CH thermocouple 5 PID control modes Output: 4-20mA	

Note 1 : Dedicated instructions for the interrupt pointer and intelligent function module cannot be used.







Pulse input/output and positioning module

Product	Type	Outline
Channel-isolated pulse input	QD60P8-G	8 channels 30kpps/10kpps/1kpps/100pps/50pps/10pps/1pps/0.1pps count input signal: 5/12 to 24VDC
High-speed counter (* 3)	QD62	2 channels 200/100/10kpps count input signal: 5/12/24VDC external input: 5/12/24VDC match output: transistor (sink) 12/24VDC, 0.5A/point, 2A/1common 40-pin connector
	QD62D	2 channels 500/200/100/10kpps count input signal: EIA Standards RS-422A (Differential line driver) external input: 5/12/24VDC match output: transistor (sink) 12/24VDC, 0.5A/point, 2A/1common 40-pin connector
	QD62E	2 channels 200/100/10kpps count input signal: 5/12/24VDC external input: 5/12/24VDC match output: transistor (source) 12/24VDC, 0.1A/point, 0.4A/common 40-pin connector
Positioning	Open collector output (* 5)	QD75P1 1-axis control unit: mm, inch, degree, pulse No. of positioning data items: 600 data items/axis max. output pulse: 200kpps 40-pin connector
		QD75P2 2-axis 2-axis linear interpolation, 2-axis circular interpolation control unit: mm, inch, degree, pulse No. of positioning data items: 600 data items/axis max. output pulse: 200kpps 40-pin connector
		QD75P4 4-axis 2-axis, 3-axis, 4-axis linear interpolation 2-axis circular interpolation control unit: mm, inch, degree, pulse No. of positioning data items: 600 data items/axis max. output pulse: 200kpps 40-pin connector
		QD70P4 4-axis control unit: pulse No. of positioning data items: 10 data items/axis max. output pulse: 200kpps 40-pin connector
		QD70P8 8-axis control unit: pulse No. of positioning data items: 10 data items/axis max. output pulse: 200kpps 40-pin connector
	Differential output (* 5)	QD75D1 1-axis control unit: mm, inch, degree, pulse No. of positioning data items: 600 data items/axis max. output pulse: 1Mpps 40-pin connector
		QD75D2 2-axis 2-axis linear interpolation, 2-axis circular interpolation control unit: mm, inch, degree, pulse No. of positioning data items: 600 data items/axis max. output pulse: 1Mpps 40-pin connector
		QD75D4 4-axis 2-axis, 3-axis, 4-axis linear interpolation 2-axis circular interpolation control unit: mm, inch, degree, pulse No. of positioning data items: 600 data items/axis max. output pulse: 1Mpps 40-pin connector
		QD70D4 4-axis control unit: pulse No. of positioning data items: 10 data items/axis max. output pulse: 4Mpps 40-pin connector Differential output
		QD70D8 8-axis control unit: pulse No. of positioning data items: 10 data items/axis max. output pulse: 4Mpps 40-pin connector Differential output
SSCNET connection (* 3)	QD75M1 1-axis control unit: mm, inch, degree, pulse No. of positioning data items: 600 data items/axis 40-pin connector	
	QD75MH1 1-axis control unit: mm, inch, degree, pulse No. of positioning data items: 600 data items/axis 40-pin connector SSCNET III connection	
	QD75M2 2-axis 2-axis linear interpolation, 2-axis circular interpolation control unit: mm, inch, degree, pulse No. of positioning data items: 600 data items/axis 40-pin connector	
	QD75MH2 2-axis 2-axis linear interpolation, 2-axis circular interpolation control unit: mm, inch, degree, pulse No. of positioning data items: 600 data items/axis 40-pin connector SSCNET III connection	
	QD75M4 4-axis 2-axis, 3-axis, 4-axis linear interpolation 2-axis circular interpolation control unit: mm, inch, degree, pulse No. of positioning data items: 600 data items/axis 40-pin connector	
QD75MH4 4-axis 2-axis, 3-axis, 4-axis linear interpolation 2-axis circular interpolation control unit: mm, inch, degree, pulse No. of positioning data items: 600 data items/axis 40-pin connector SSCNET III connection		











Note 1 : Dedicated instructions for the interrupt pointer and intelligent function module cannot be used.





Information module

Ethernet  	QJ71E71-100	10BASE-T/100BASE-TX
	QJ71E71-B2	10BASE2
	QJ71E71-B5	10BASE5
Serial communication  	QJ71C24N	RS-232 1 channel RS-422/485 1 channel Transmission speed: 230.4kbps total for two channels GX Configurator-SC Version 2 compatible
	QJ71C24N-R2	RS-232 2 channel Transmission speed: 230.4kbps total for two channels GX Configurator-SC Version 2 compatible
	QJ71C24N-R4	RS-422/485 2 channels Transmission speed: 230.4kbps total for two channels GX Configurator-SC Version 2 compatible
Intelligent communication  	QD51	Basic program execution module RS-232 2 channels
	QD51-R24	Basic program execution module RS-232 1 channel RS-422/485 1 channel
	SW□ IVD-AD51HP (* 7)	QD51H software package (shared between AD51H-S3/A1SD51HS)

Control network module

MELSEC NET/H	SI/QSI optical cable 	QJ71LP21-25	SI, QSI, H-PCF, broadband H-PCF optical cable duplex loop PLC-to-PLC network (control station/normal station)/ remote I/O network (remote master station)
		QJ71LP21S-25	SI, QSI, H-PCF, broadband H-PCF optical cable duplex loop PLC-to-PLC network (control station/normal station)/ remote I/O network (remote master station) external supply power function
		QJ72LP25-25	SI, QSI, H-PCF, broadband H-PCF optical cable duplex loop Remote I/O network (remote I/O station)
	GI-50/125 optical cable 	QJ71LP21G	GI-50/125 optical cable duplex loop PLC-to-PLC network (control station/normal station)/ remote I/O network (remote master station)
		QJ72LP25G	GI-50/125 optical cable duplex loop Remote I/O network (remote I/O station)
	GI-62.5/125 optical cable 	QJ71LP21GE	GI-62.5/125 optical cable duplex loop PLC-to-PLC network (control station/normal station)/ remote I/O network (remote master station)
		QJ72LP25GE	GI-62.5/125 optical cable duplex loop Remote I/O network (remote I/O station)
	Coaxial cable 	QJ71BR11	3C-2V/5C-2V coaxial cable simplex bus PLC-to-PLC network (control station/normal station)/ remote I/O network (remote master station)
		QJ72BR15	3C-2V/5C-2V coaxial cable simplex bus Remote I/O network (remote I/O station)
	CC-Link  	QJ61BT11N	Master station/local station combined use, CC-Link Ver. 2 compatible
CC-Link/LT 	QJ61CL12	Master station	
FL-net (OPCN-2)  	QJ71FL71-T-F01	10BASE-T	
	QJ71FL71-B2-F01	10BASE2	
	QJ71FL71-B5-F01	10BASE5	
AS-i 	QJ71AS92	Master station, AS-i standard version 2.11 compatible	

 : Dedicated instructions for the interrupt pointer and intelligent function module cannot be used.

 : Dedicated instructions for the interrupt pointer and intelligent function module, and the e-mail function cannot be used.

A mode CPU, base

Product	Type	Outline	
CPU	Q02CPU-A	For A mode No. of input points: 4096 points No. of input/output device points: 8192 points Program capacity: 28k steps Basic instruction processing speed (LD instruction): 0.079μs Program memory capacity: 144kbyte	
	Q02HCPU-A	For A mode No. of input points: 4096 points No. of input/output device points: 8192 points Program capacity: 28k steps Basic instruction processing speed (LD instruction): 0.034μs Program memory capacity: 144kbyte	
	Q06HCPU-A	For A mode No. of input points: 4096 points No. of input/output device points: 8192 points Program capacity: 30k steps (main) 30k steps (sub) Basic instruction processing speed (LD instruction): 0.034μs Program memory capacity: 144kbyte	
Base	Main base	QA1S33B	3 slots, power supply module mountable, for AnS series modules
		QA1S35B	5 slots, power supply module mountable, for AnS series modules
		QA1S38B	8 slots, power supply module mountable, for AnS series modules
	Extension base	QA1S65B	5 slots, power supply module mountable, for AnS series modules
		QA1S68B	8 slots, power supply module mountable, for AnS series modules

MELSOFT GX Series

GX Developer	SW□D5C-GPPW-E	MELSEC PLC programming software
	SW□D5C-GPPW-EV	MELSEC PLC programming software (Upgrade)
GX Simulator	SW□D5C-LLT-E	MELSEC PLC simulation software
	SW□D5C-LLT-EV	MELSEC PLC simulation software (Upgrade)
GX Explorer	SW□D5C-EXP-E	Maintenance tool
	SW□D5C-EXP-EV	Maintenance tool (Upgrade)
GX Converter	SW□D5C-CNVW-E	Excel®/text data converter
GX Configurator-AD (* 7)	SW□D5C-QADU-E	MELSEC-Q dedicated analog to digital module setting/monitoring tool
GX Configurator-DA (* 7)	SW□D5C-QDAU-E	MELSEC-Q dedicated digital to analog module setting/monitoring tool
GX Configurator-SC (* 7)	SW□D5C-QSCU-E	MELSEC-Q dedicated serial communication module setting/monitoring tool
GX Configurator-CT (* 7)	SW□D5C-QCTU-E	MELSEC-Q dedicated counter module setting/monitoring tool
GX Configurator-TC (* 7)	SW□D5C-QTCU-E	MELSEC-Q dedicated temperature control module setting/monitoring tool
GX Configurator-TI (* 7)	SW□D5C-QTIU-E	MELSEC-Q dedicated temperature input module setting/monitoring tool
GX Configurator-FL (* 7)	SW□D5C-QFLU-E	MELSEC-Q dedicated FL-net module setting/monitoring tool
GX Configurator-PT (* 7)	SW□D5C-QPTU-E	MELSEC-Q dedicated QD70P positioning module setting/monitoring tool
GX Configurator-AS (* 7)	SW□D5C-QASU-E	MELSEC-Q dedicated AS-i master module setting/monitoring tool
GX Configurator-QP (* 7)	SW□D5C-QD75P-E	MELSEC-Q dedicated QD75P/D/M positioning module setting/monitoring tool
GX Configurator-CC (* 7)	SW□D5C-J61P-E	CC-Link module setting/monitoring tool
GX RemoteService-I	SW□D5C-RAS-E	Remote access tool
	SW□D5C-RAS-EV	Remote access tool (Upgrade)
GX Works	SW□D5C-QSET-E	A set of seven products, GX Developer, GX Simulator, GX Explorer, GX Configurator-AD, DA, SC, CT
	SW□D5C-GPPLT-E	A set of three products, GX Developer, GX Simulator, GX Explorer

MELSOFT PX Series

PX Developer (* 7)	SW□D5C-FBDQ-E	FBD Software package for process control
PX Works	SW□D5C-FBDGPP-E	A set of six products, PX Developer, GX Developer, GX Configurator-AD, DA, CT, and TI

MELSOFT MX Series

MX Component	SW□D5C-ACT-E	Active X library for communication
MX Sheet	SW□D5C-SHEET-E	Excel®communication support tool
MX Works	SW□D5C-SHEETSET-E	A set of two products, MX Component, MX Sheet

MELSOFT MT Series

MT Developer	SW□RNC-GSVPROE	Integral startup support software for Q Motion
	SW□RNC-GSVSETE	Integral startup support software for Q Motion + A30CD-PCF SSC I/F card + Q170CDCBL3M cable

MELSOFT MR Series

MR Configurator (* 9)	MRZJW3-SETUP221	Servo setup software for personal computer
-----------------------	-----------------	--

PC I/F Board

MELSEC NET/H (10)	SI/QSI optical cable	Q80BD-J71LP21-25	PCI bus Japanese/English OS compatible SI/QSI optical cable duplex loop PLC-to-PLC network (control station, normal station)
		Q80BD-J71LP21S-25	PCI bus Japanese/English OS compatible SI/QSI optical cable duplex loop PLC-to-PLC network (control station, ordinary station) With external power supply function
	Coaxial cable	Q80BD-J71LP21G	PCI bus Japanese/English OS compatible GI-62.5/125 optical cable duplex loop PLC-to-PLC network (control station, ordinary station)
		Q80BD-J71BR11	PCI bus Japanese/English OS compatible GI-62.5/125 optical cable duplex loop PLC-to-PLC network (control station, ordinary station)
CC-Link	A80BDE-J61BT11	PCI bus Japanese/English OS compatible Shared by master station and local station CC-Link Ver.2 compatible	

- * 1) Compatible only with high-performance module
- * 2) "Positive common" refers to using the sensor with the positive DC power connected to the common terminal. "Negative common" refers to using the sensor with the negative DC power connected to the common terminal.
- * 3) The connector is not enclosed. Prepare the A6CON1, A6CON2, A6CON3 or A6CON4 connector.
- * 4) No connector is provided. Please acquire the A6CON1E/A6CON2E/A6CON3E separately.
- * 5) No connector is provided. Please acquire the A6CON1/A6CON2/A6CON3 separately.
- * 6) Runs at the Windows command prompt.
- * 7) Not compatible with the A mode.

Mitsubishi Programmable Logic Controller

Precautions for Choosing the Products

This catalog explains the typical features and functions of the Q series PLCs and does not provide restrictions and other information on usage and module combinations. When choosing the products, always check the detailed specifications, restrictions, etc. of the products in the Q series data book. When using the products, always read the user's manuals of the products.

Mitsubishi will not be held liable for damage caused by factors found not to be the cause of Mitsubishi; machine damage or lost profits caused by faults in the Mitsubishi products; damage, secondary damage, accident compensation caused by special factors unpredictable by Mitsubishi; damages to products other than Mitsubishi products; and to other duties.

⚠ For safe use

- To use the products given in this catalog properly, always read the "manuals" before starting to use them.
- This product has been manufactured as a general-purpose part for general industries, and has not been designed or manufactured to be incorporated in a device or system used in purposes related to human life.
- Before using the product for special purposes such as nuclear power, electric power, aerospace, medicine or passenger movement vehicles, consult with Mitsubishi.
- This product has been manufactured under strict quality control. However, when installing the product where major accidents or losses could occur if the product fails, install appropriate backup or failsafe functions in the system.

Country/Region	Sales office	Tel/Fax
U.S.A	Mitsubishi Electric Automation Inc. 500 Corporate Woods Parkway Vernon Hills, IL 60061	Tel : +1-847-478-2100 Fax : +1-847-478-2396
Brazil	MELCO-TEC Rep. Com.e Assessoria Tecnica Ltda. Rua Correia Dias, 184, Edificio Paraiso Trade Center-8 andar Paraiso, Sao Paulo, SP Brazil	Tel : +55-11-5908-8331 Fax : +55-11-5574-5296
Germany	Mitsubishi Electric Europe B.V. German Branch Gothaer Strasse 8 D-40880 Ratingen, GERMANY	Tel : +49-2102-486-0 Fax : +49-2102-486-7170
U.K	Mitsubishi Electric Europe B.V. UK Branch Travellers Lane, Hatfield, Herts., AL10 8XB,UK	Tel : +44-1707-276100 Fax : +44-1707-278695
Italy	Mitsubishi Electric Europe B.V. Italian Branch Centro Dir. Colleoni, Pal. Perseo - Ingr.2 Via Paracelso 12, 20041 Agrate B., Milano, Italy	Tel : +39-039-60531 Fax : +39-039-6053312
Spain	Mitsubishi Electric Europe B.V. Spanish Branch Carretera de Rubi 76-80 08190 Sant Cugat del Valles, Barcelona, Spain	Tel : +34-93-565-3131 Fax : +34-93-589-2948
France	Mitsubishi Electric Europe B.V. French Branch 25 Boulevard des Bouvets, F-92741 Nanterre Cedex, France	Tel : +33-1-5568-5568 Fax : +33-1-5568-5685
South Africa	Circuit Breaker Industries LTD Private Bag 2016, 1600 Isando, Tripswitch Drive, Elandsfontein Gauteng, South Africa	Tel : +27-11-928-2000 Fax : +27-11-392-2354
Hong Kong	Mitsubishi Electric Automation (Hong Kong) Ltd. 10th Floor, Manulife Tower, 169 Electric Road, North Point, HongKong	Tel : +852-2887-8870 Fax : +852-2887-7984
China	Mitsubishi Electric Automation (Shanghai) Ltd. 80 Xin Chang Road, 4th Floor Shanghai Intelligence Fortune Leisure Plaza, Huang Pu district Shanghai 200003, P. R. China	Tel : +86-21-6120-0808 Fax : +86-21-6121-2424
Taiwan	Setsuyo Enterprise Co., Ltd. 6F., No.105 Wu-Kung 3rd.RD, Wu-Ku Hsiang, Taipei Hsine, Taiwan	Tel : +886-2-2299-2499 Fax : +886-2-2299-2509
Korea	Mitsubishi Electric Automation Korea Co., Ltd. B1F, 2F, 1480-6, Deungchon-Dong, Kangseo-Ku, Seoul, 157-200, Korea	Tel : +82-2-3660-9607 Fax : +82-2-3664-0475
Singapore	Mitsubishi Electric Asia Pte, Ltd. 307 Alexandra Road #05-01/02, Mitsubishi Electric Bulding Singapore 159943	Tel : +65-6470-2460 Fax : +65-6476-7439
Thailand	F.A. Tech Co., Ltd. 896/19, 20, 21, 22, S. V. City Building, Office Tower 1, Floor 12 Rama III Rd, Bangpongpan, Yannawa, Bangkok 10120	Tel : +66-2-682-6522 Fax : +66-2-682-6020
Indonesia	Indonesia P.T. Autoteknindo SUMBER MAKMUR Muara Karang Selatan Block A/Utara No.1 Kav. No.11 Kawasan Industri/Pergudangan Jakarta-Utara 14440	Tel : +62-21-663-0833 Fax : +62-21-663-0832
India	Messung Systems Pvt, Ltd. Electronic Sadan NO:111 Unit No15, M.I.D.C Bhosari, Pune-411026, India	Tel : +91-20-2712-3130 Fax : +91-20-2712-8180
Australia	Mitsubishi Electric Australia Pty. Ltd. 348 Victoria Road, Rydalmere, N.S.W 2116, Australia	Tel : +61-2-9684-7777 Fax : +61-2-9684-7245



HEAD OFFICE: TOKYO BUILDING, 2-7-3 MARUNOUCHI, CHIYODA-KU, TOKYO 100-8310, JAPAN
NAGOYA WORKS: 1-14, YADA-MINAMI 5, HIGASHI-KU, NAGOYA, JAPAN

When exported from Japan, this manual does not require application to the Ministry of International Trade and Industry for service transaction permission.